

NEST

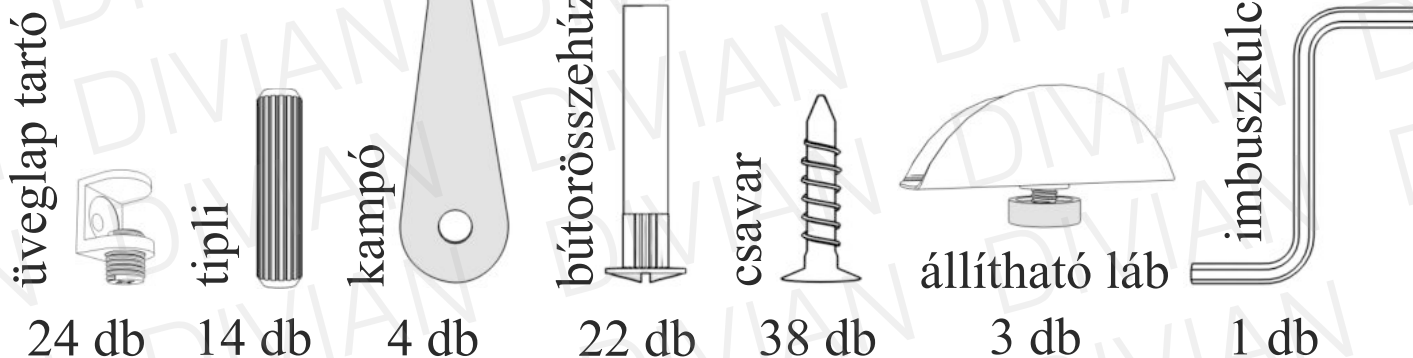

SZERELÉSI ÚTMUTATÓ

Csomag tartalma:



Ne egyedül végezze az összeállítást!

Szekrényelem rögzítő tartalma:

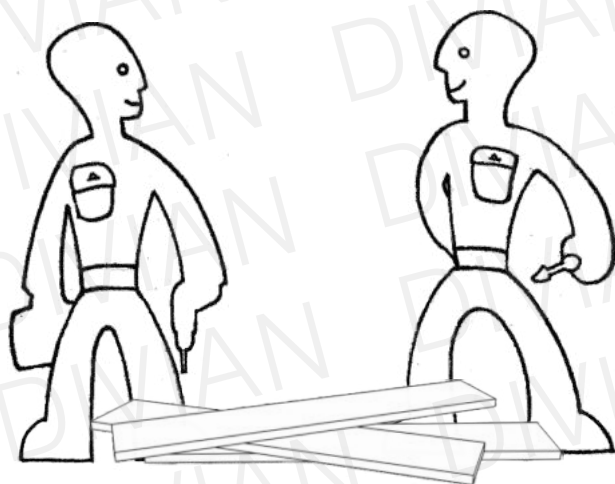

Szükséges szerszámok:

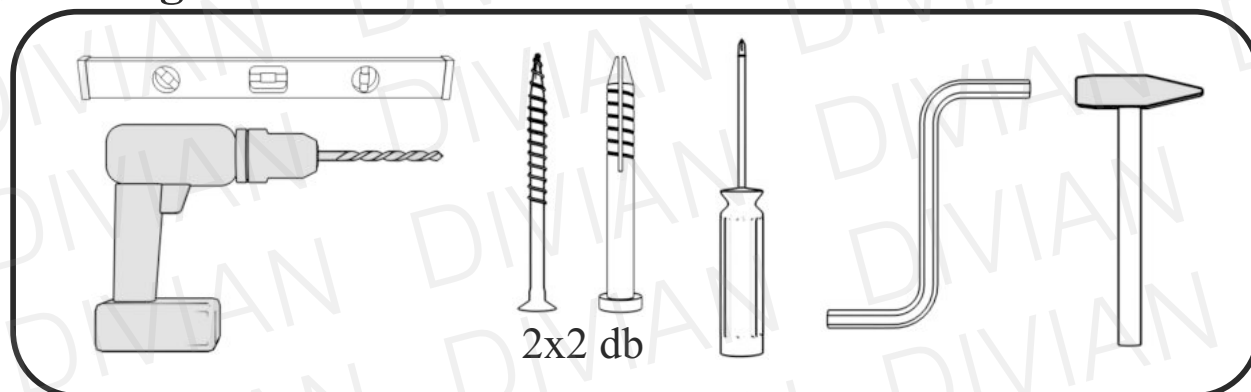

Óvja az elemeket a sérülésektől!

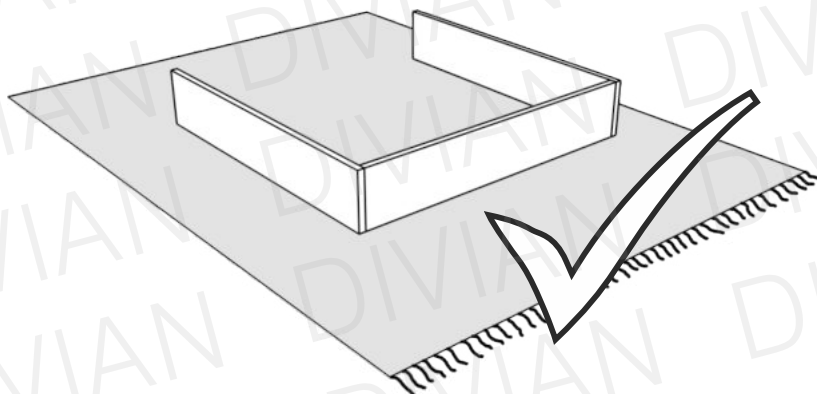
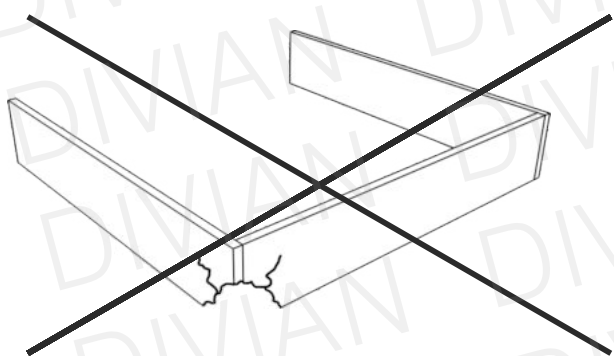

ELEMEEK

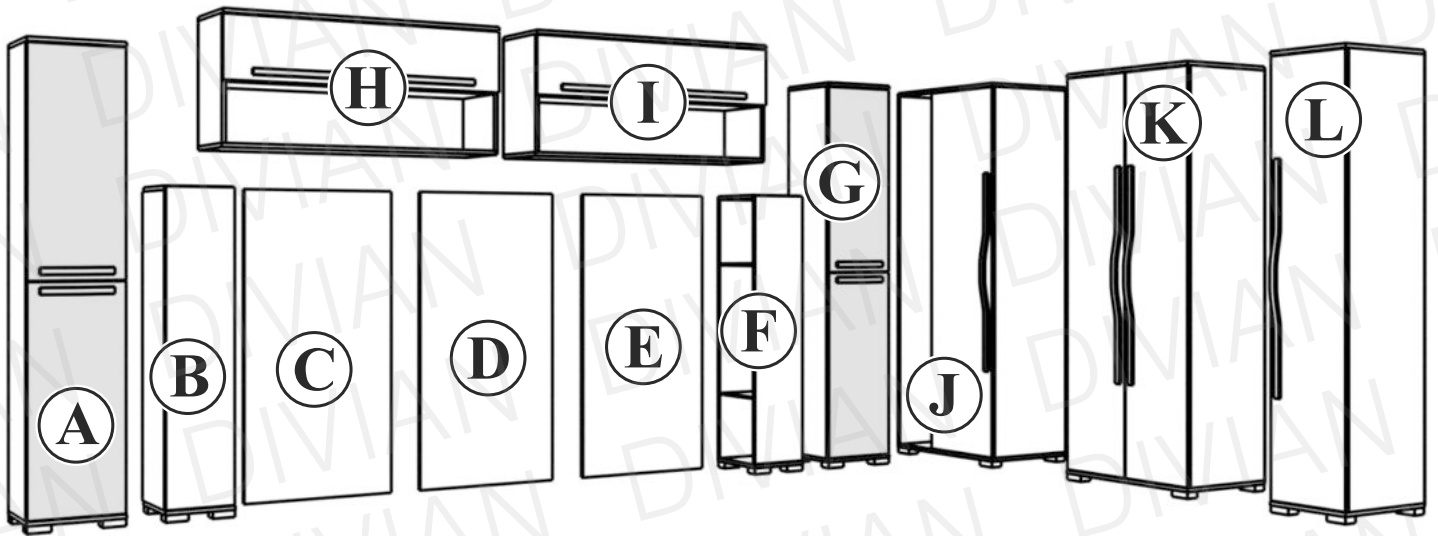

A könnyebb áttekinthetőség érdekében a szerelési útmutatóban az adott elemeket ajtók nélkül ábrázoljuk. Az összeszereléshez Önnek természetesen nem szükséges levennie az ajtókat!

1

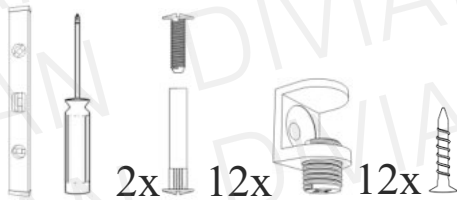

Hátfalak síkban legyenek.

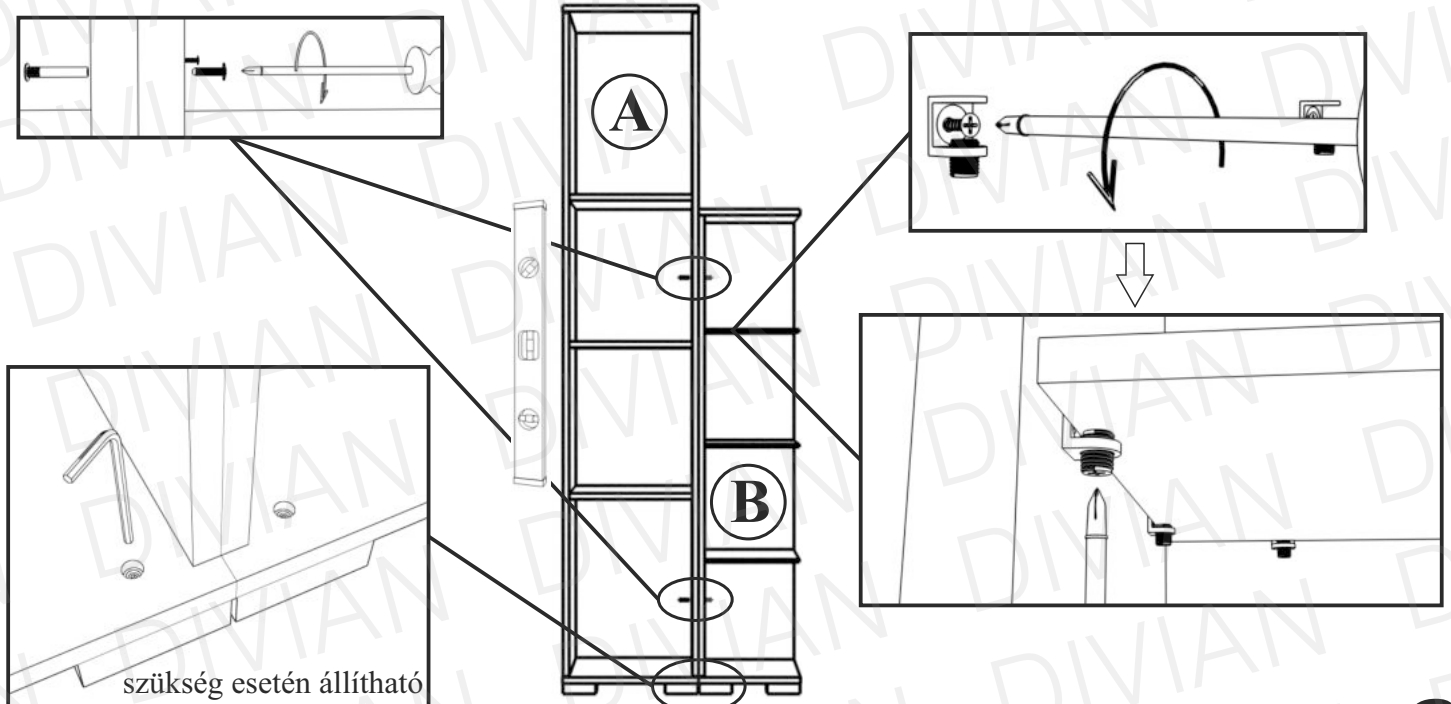

2

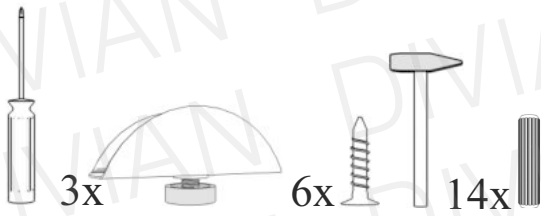

tiplik behelyezése

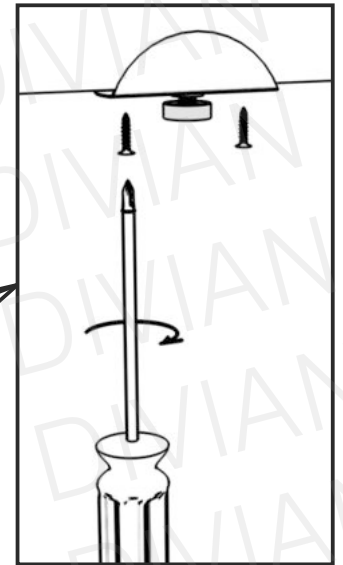
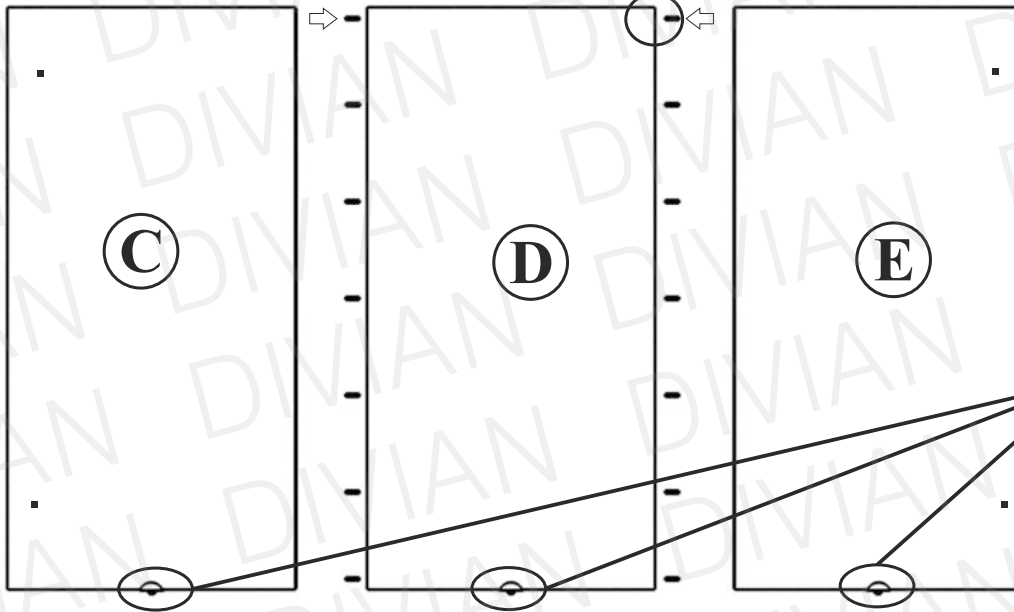
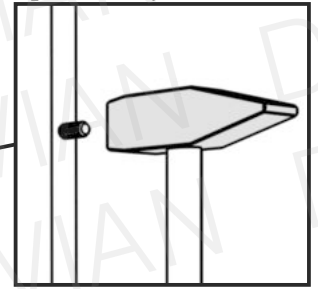

3

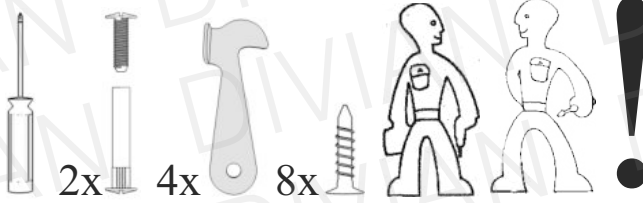

hátdoldalon kampó rögzítése

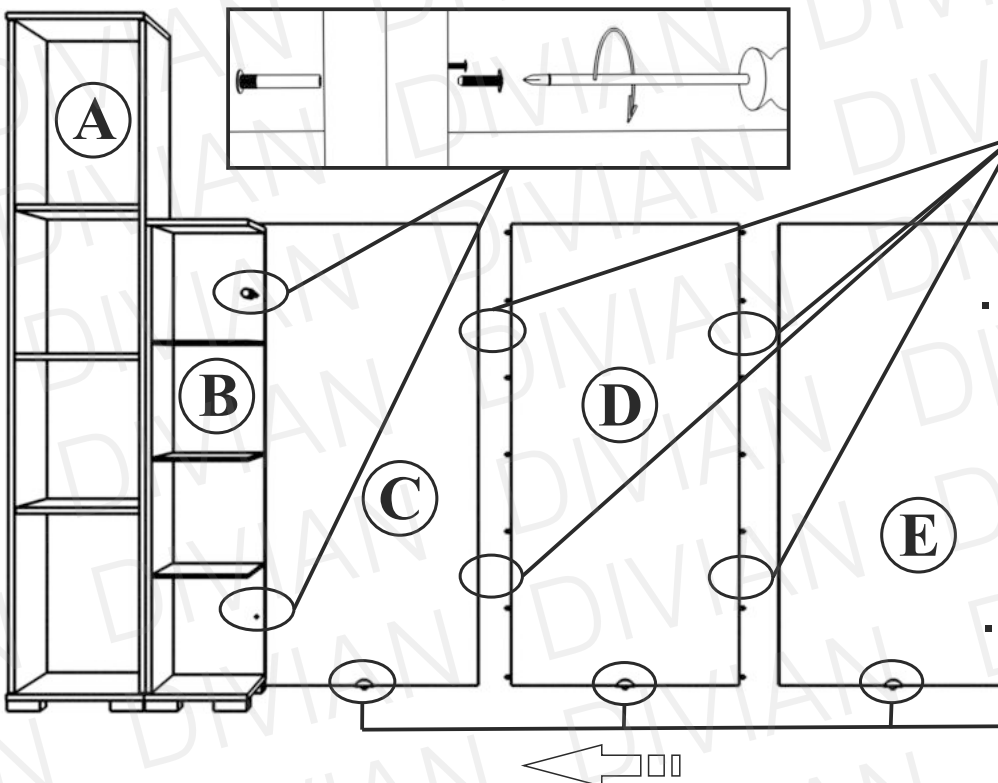
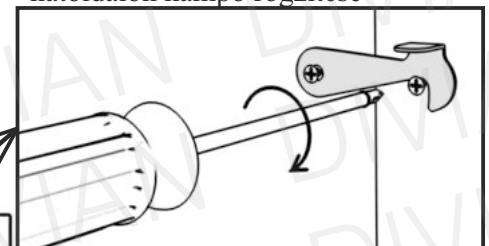

szükség esetén állítható



3

4

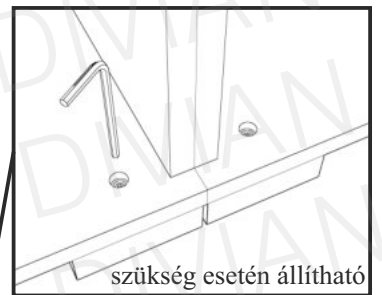
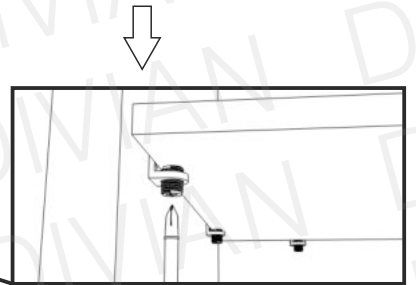
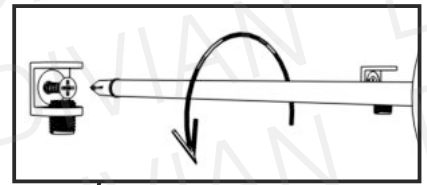
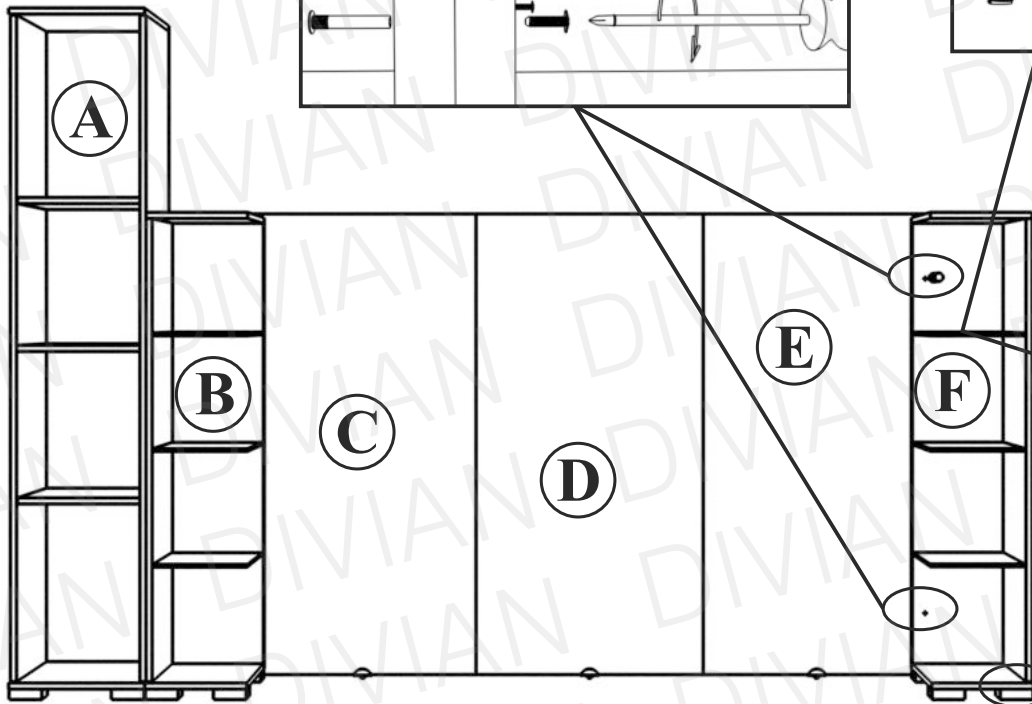
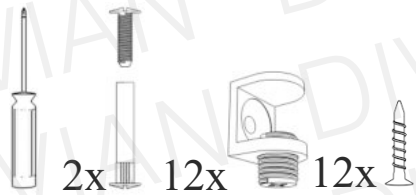

5

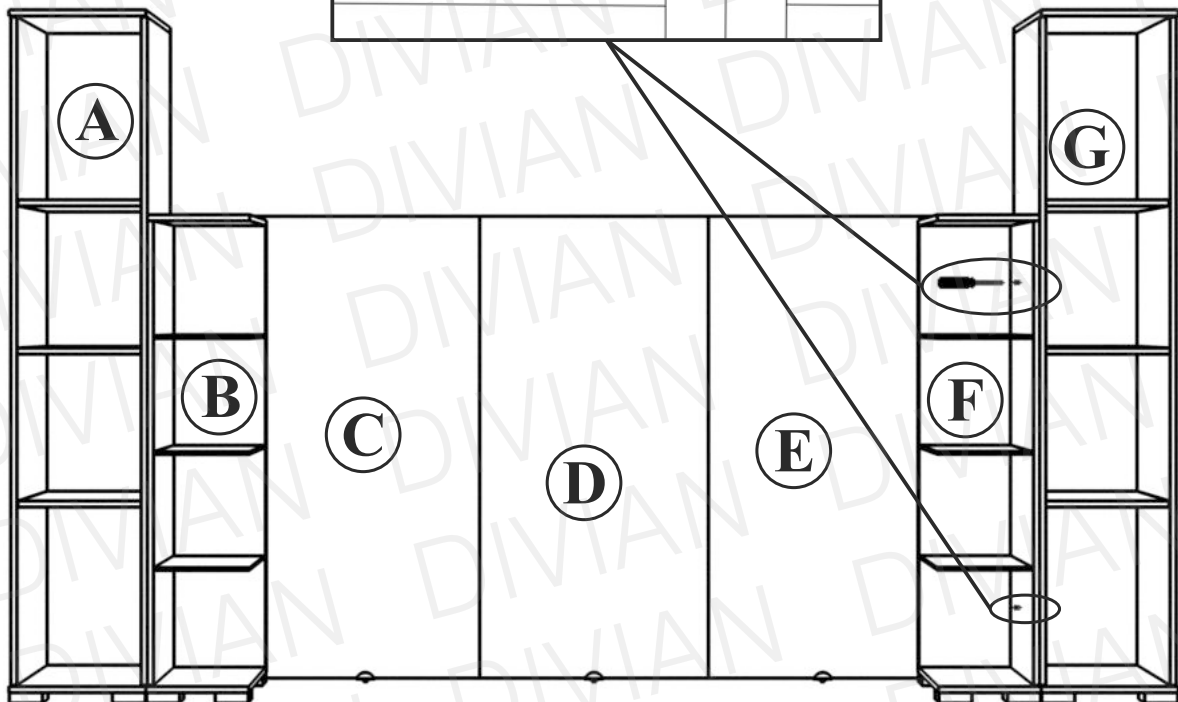

6

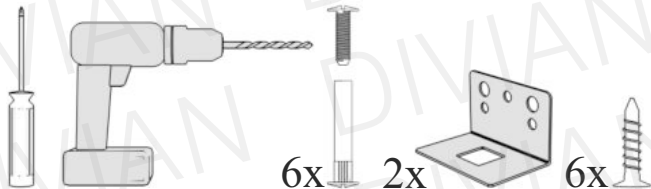

i

H és I elem összeszerelése földön történjen!

i

H és I elem hátfalát furja ki!

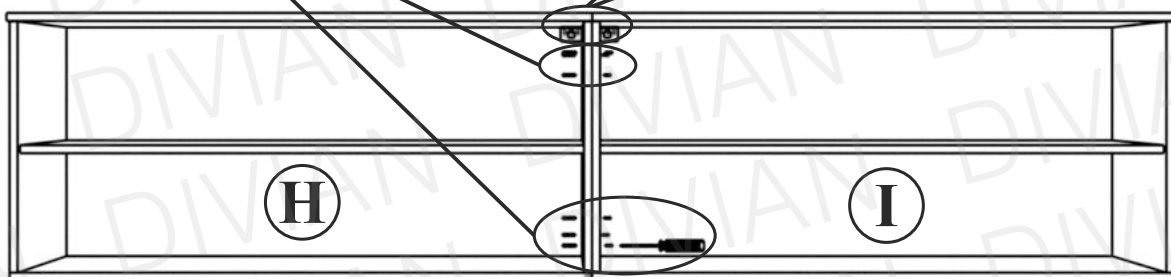
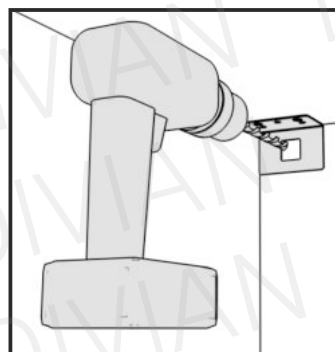
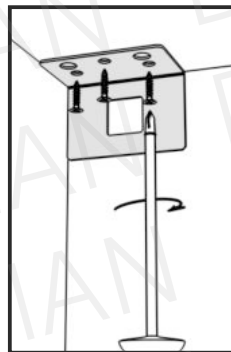
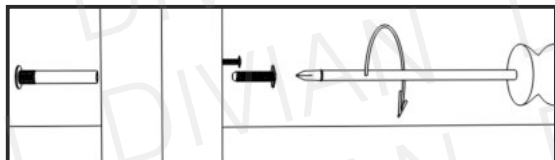

7

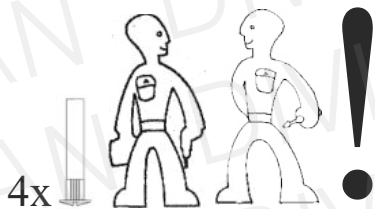

i

H és I elemet emelje a helyére, a bútörösszehúzó hüvelyének segítségével ideiglenesen rögzítse! Jelölje ki a tipli helyét a mögöttes falon!

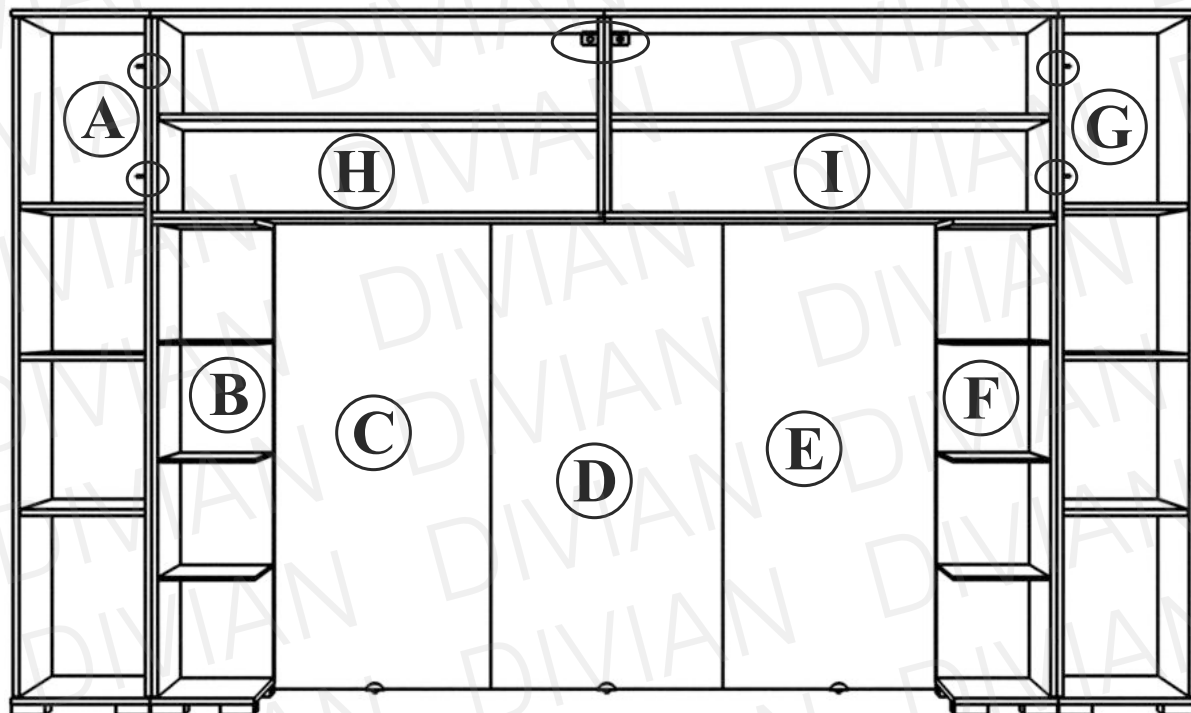

8

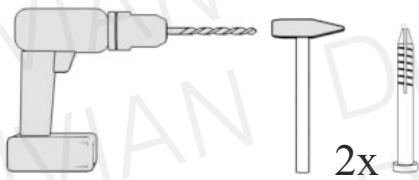

i

H és I elemet tegye a földre,
furja ki a bejelölt pontokat a falon!
Üsse be a tipliket!

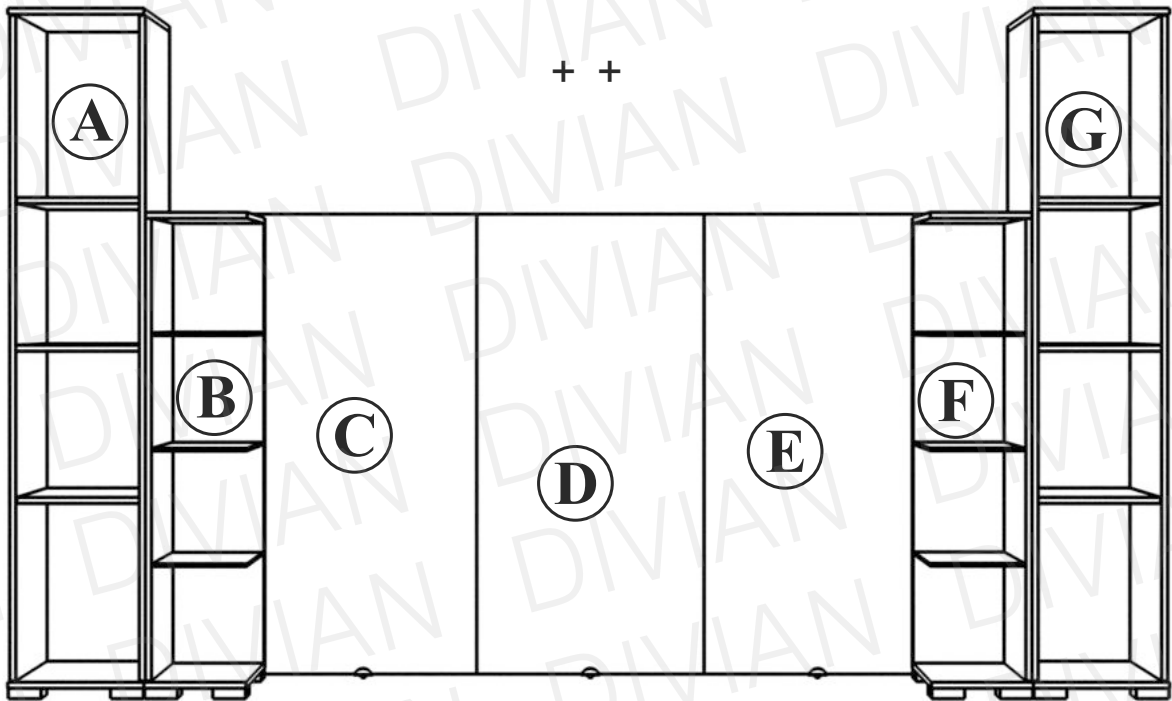

9

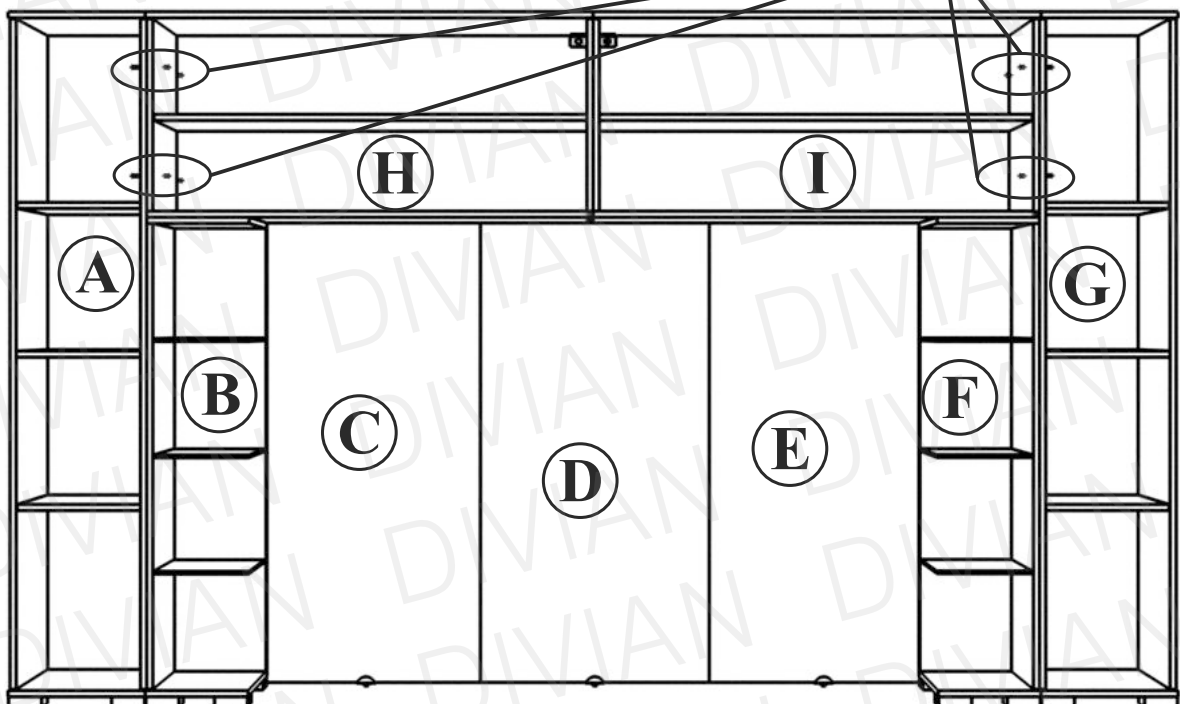
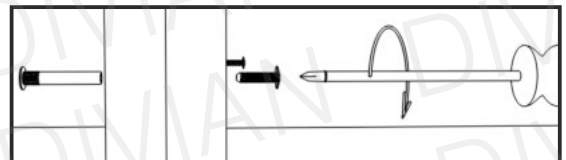
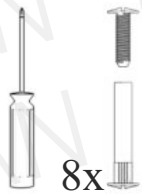

10

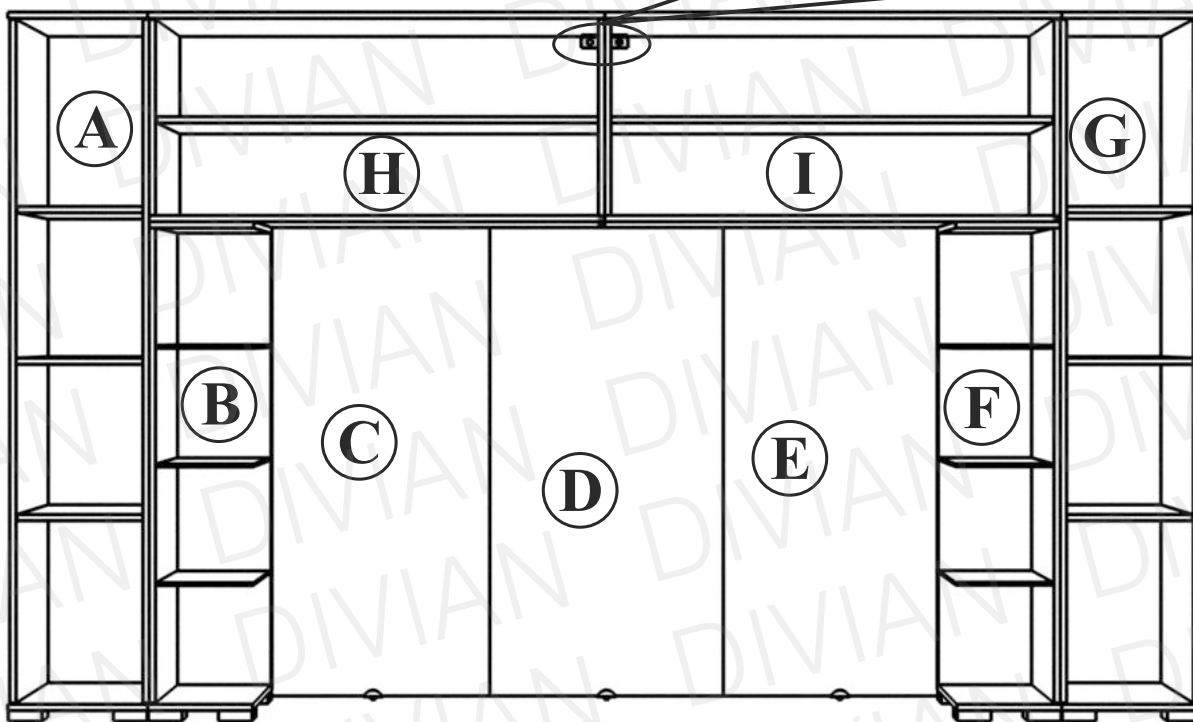
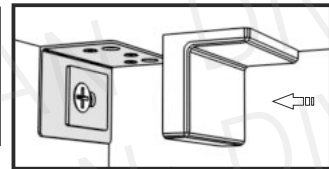
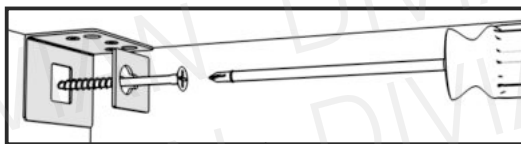
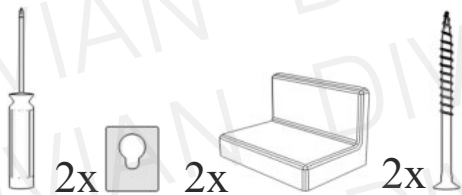

11

i

J elem megfordításával, és a lábak/mándlirúd áthelyezésével, a garnitúra összeállítható jobbos és balos kivitelben egyaránt.

