

KOMFORT

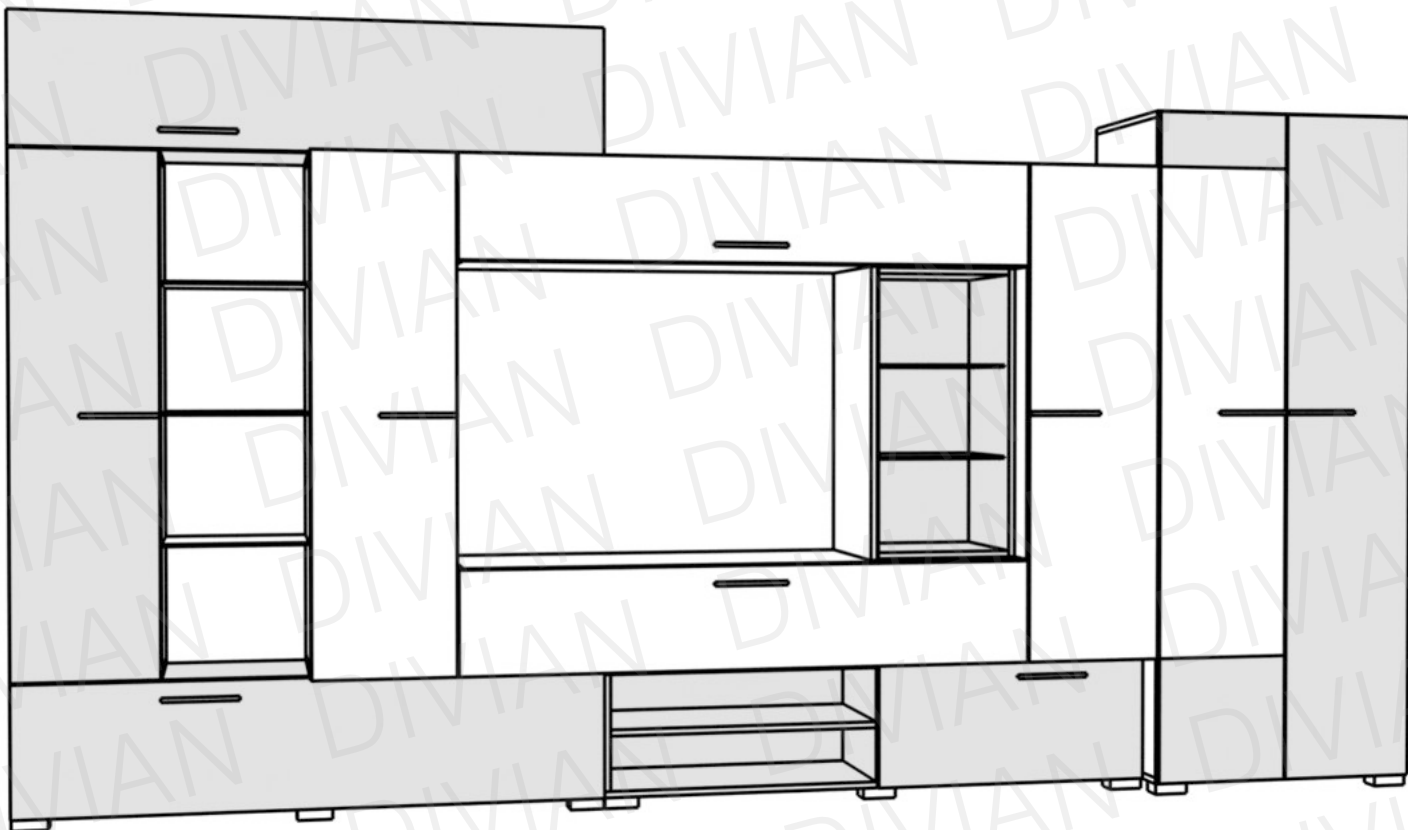

SZERELÉSI ÚTMUTATÓ

Csomag tartalma:

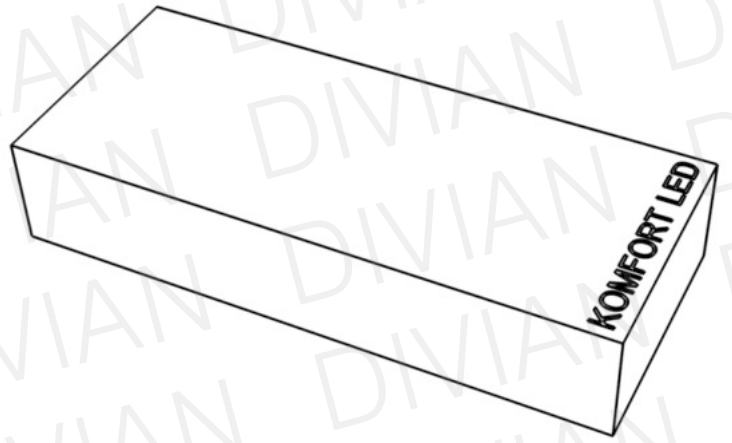

Ne egyedül végezze az összeállítást!

Szükséges szerszámok:

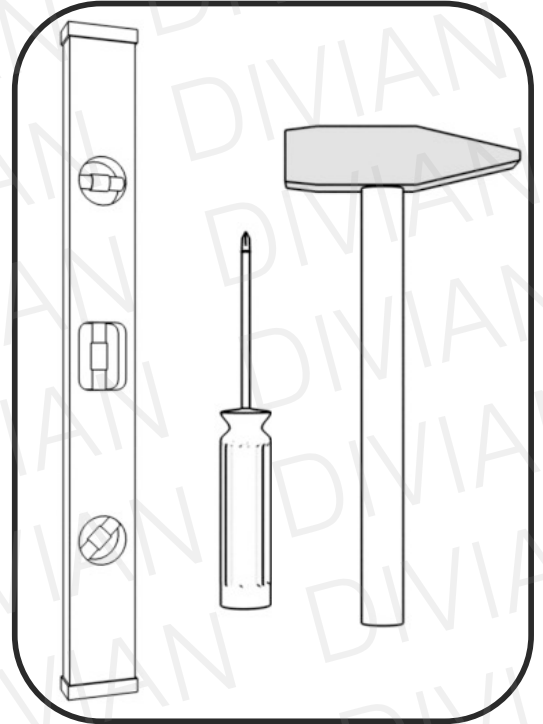
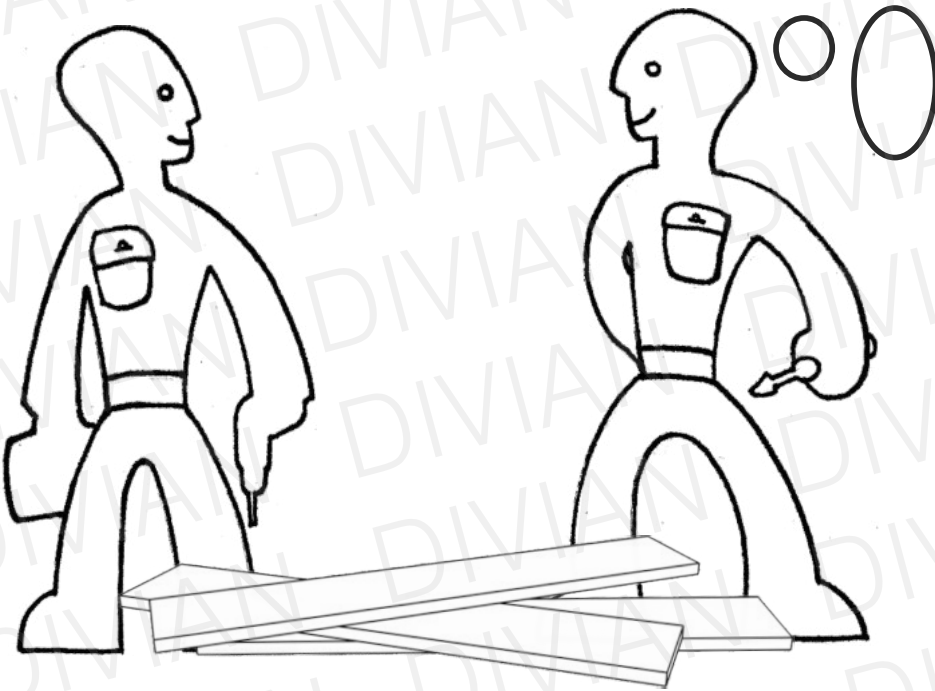

Óvja az elemeket a sérülésektől!

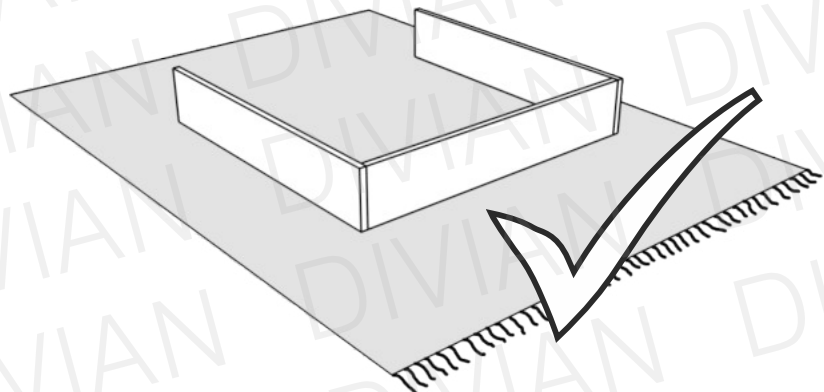
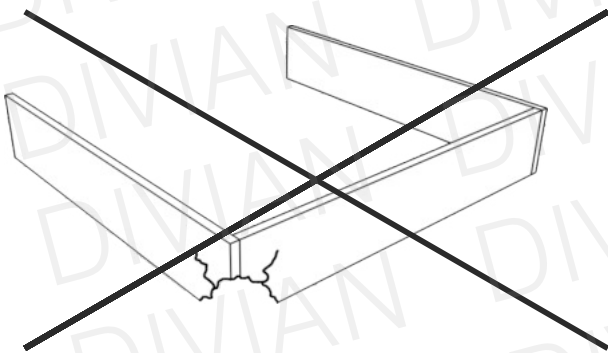

ELEMEK

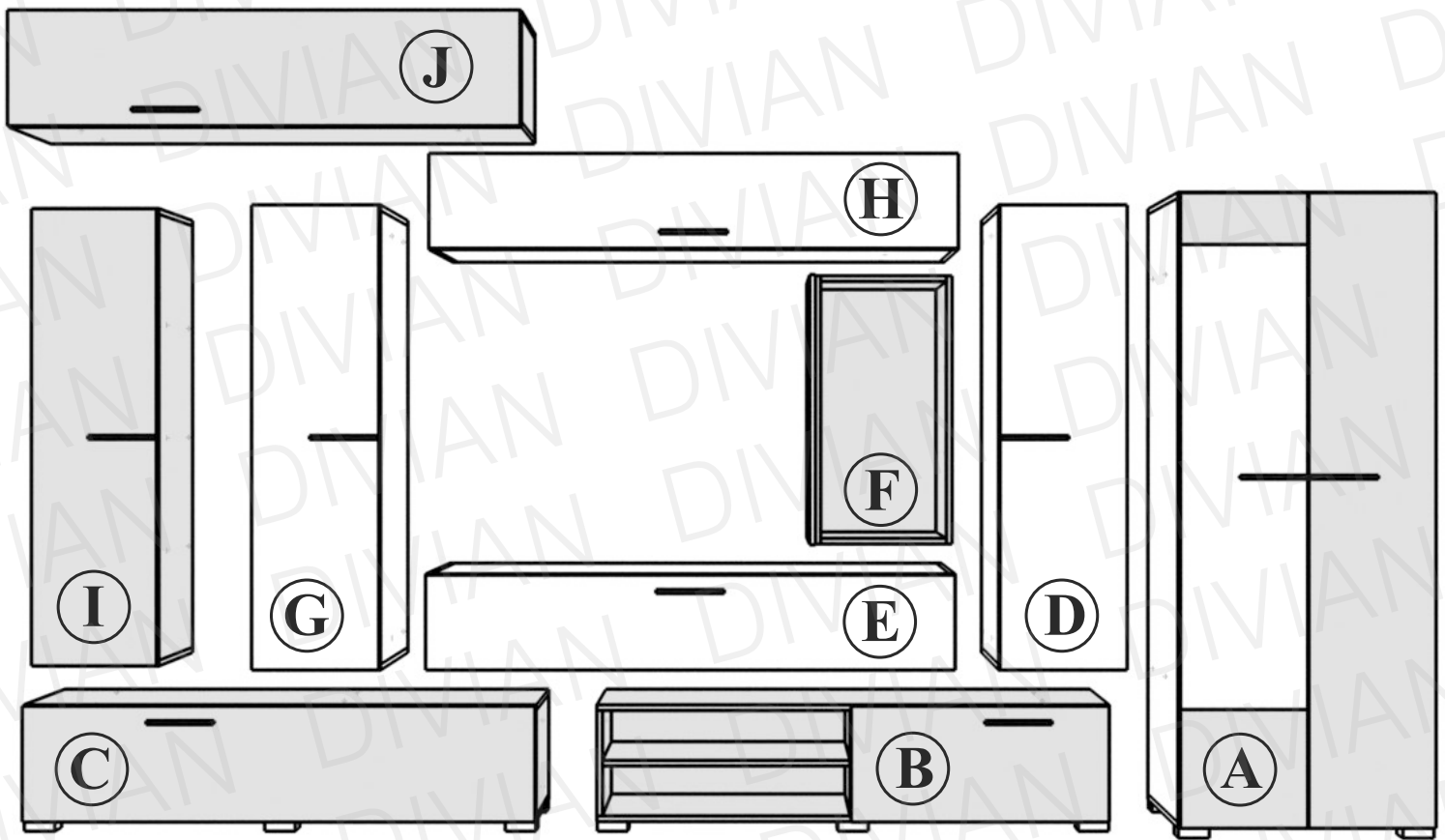

A könnyebb áttekinthetőség érdekében a szerelési útmutatóban az adott elemeket ajtókat nélkül ábrázoljuk. Az összeszereléshez Önnek természetesen nem szükséges levennie az ajtókat!

D **G** ELEMÉK MEGKÜLÖNBÖZTETÉSE

- D** A „D” elemet felállítva az elem mindkét hosszanti oldalfalán 4-4 átmenő furatot találunk
- G** A „G” elemet felállítva csak az elem jobb (fogó felőli) oldalán található 4 db átmenő furat!

1



i

Hátfalak síkban legyenek.

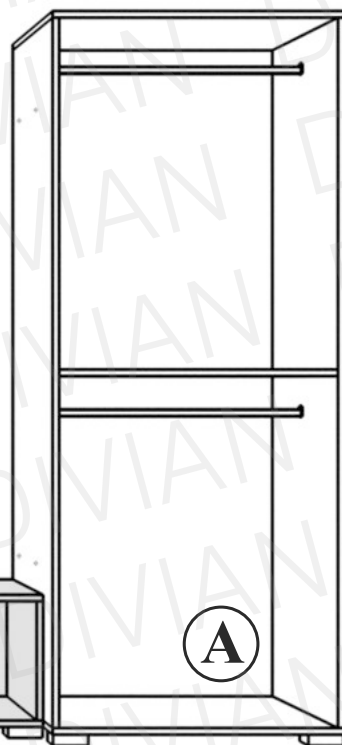
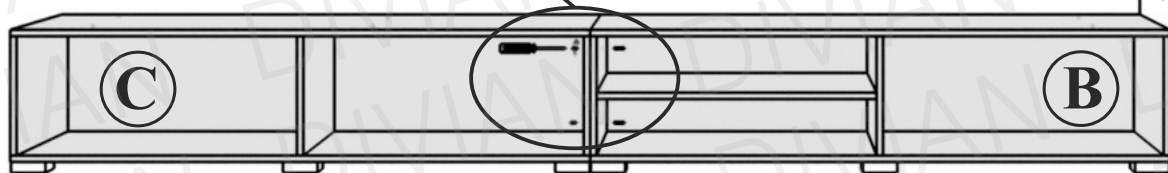
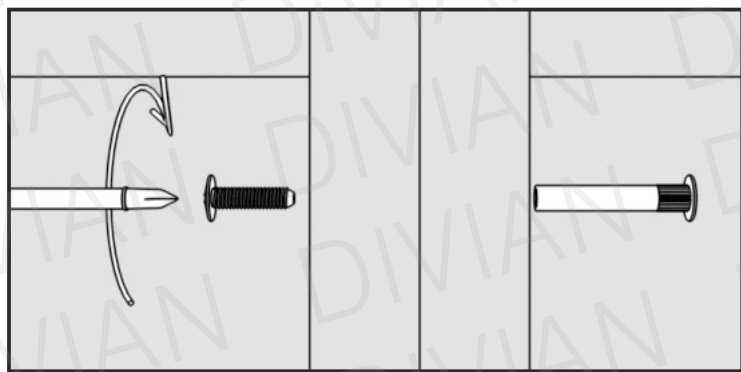

2



i

ⓓ Fogó a bal oldalon, ajtó jobbra nyílik!
Hátfalak síkban legyenek.

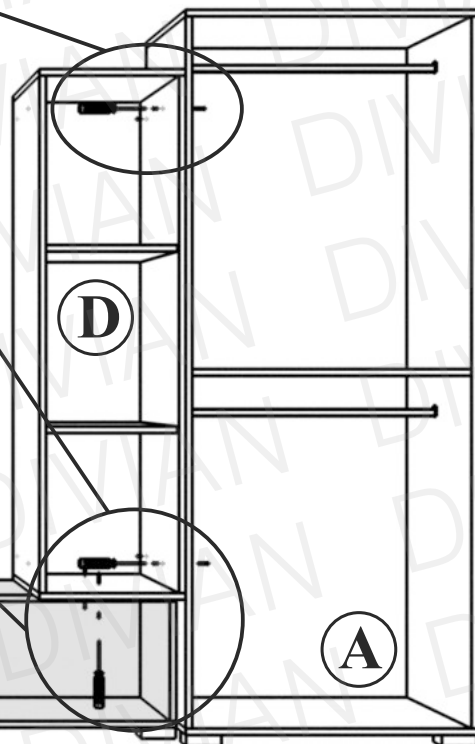
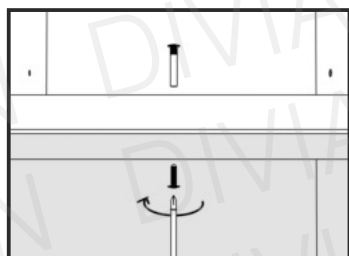
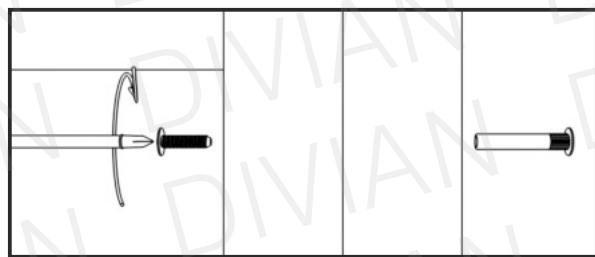

3

3



i **E** Fogó felül, belül 3 részre osztott.
Hátfalak síkban legyenek.

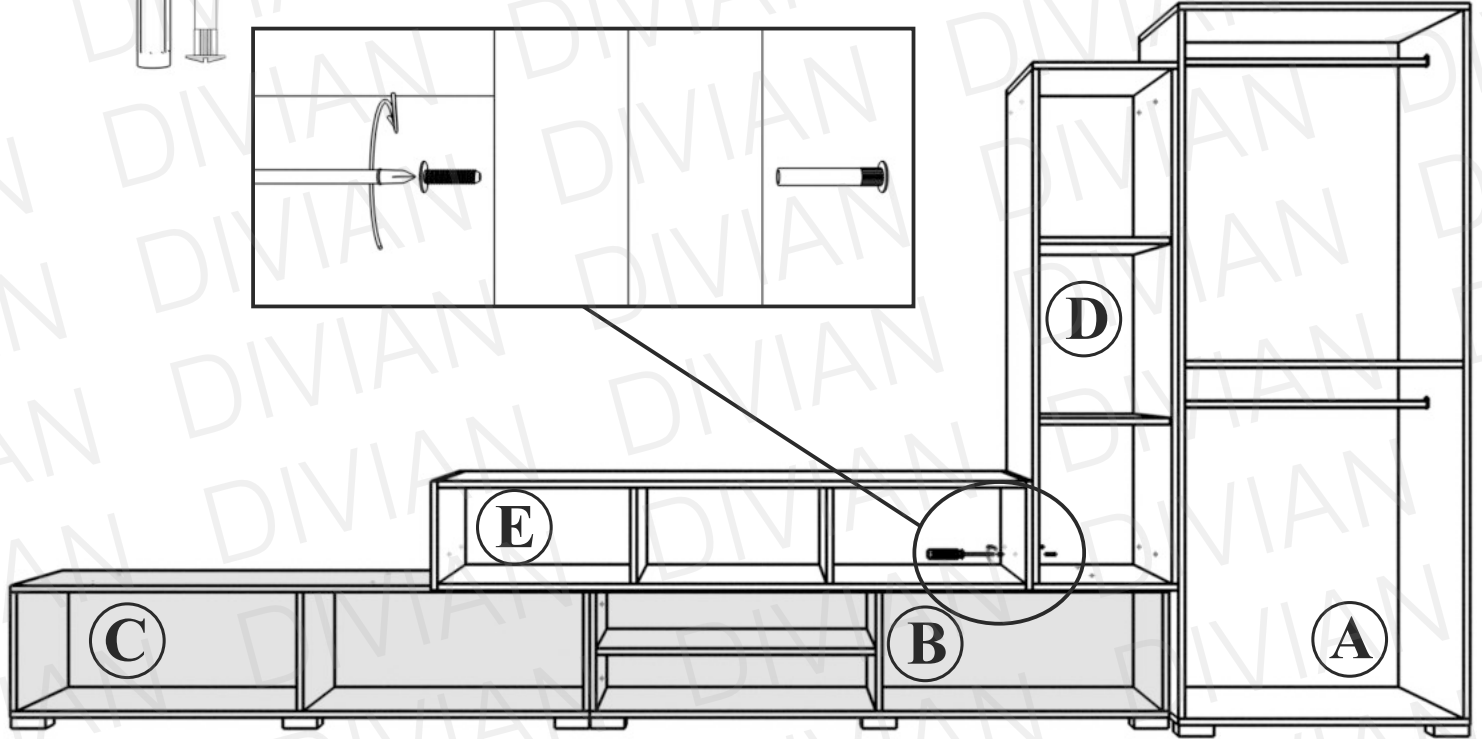

4



i **F** Bal oldal dupla **G** Fogó jobb oldalt
Hátfalak síkban legyenek.

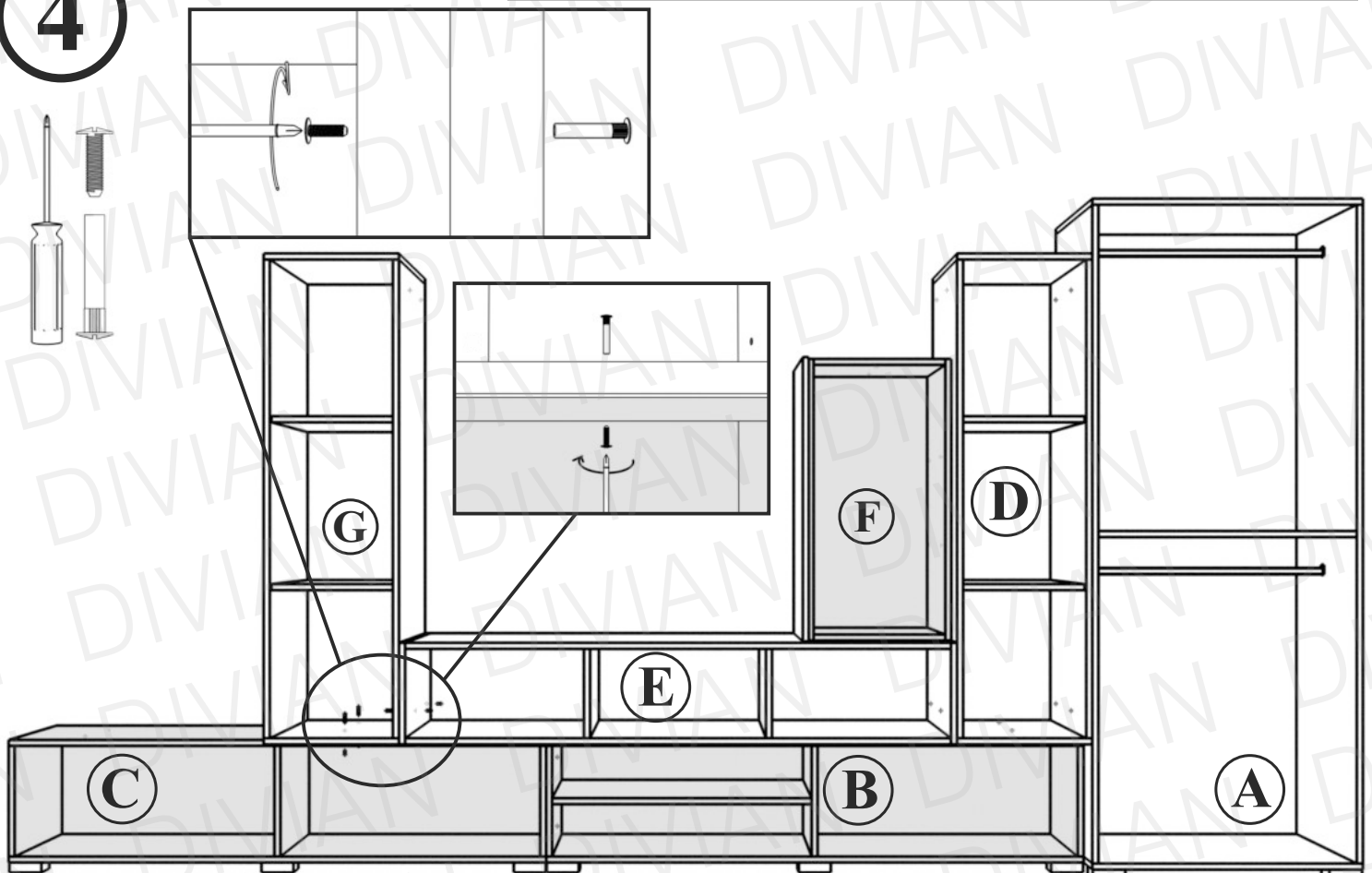

5



i

H

Fogó alul. Hátfalak síkban legyenek.

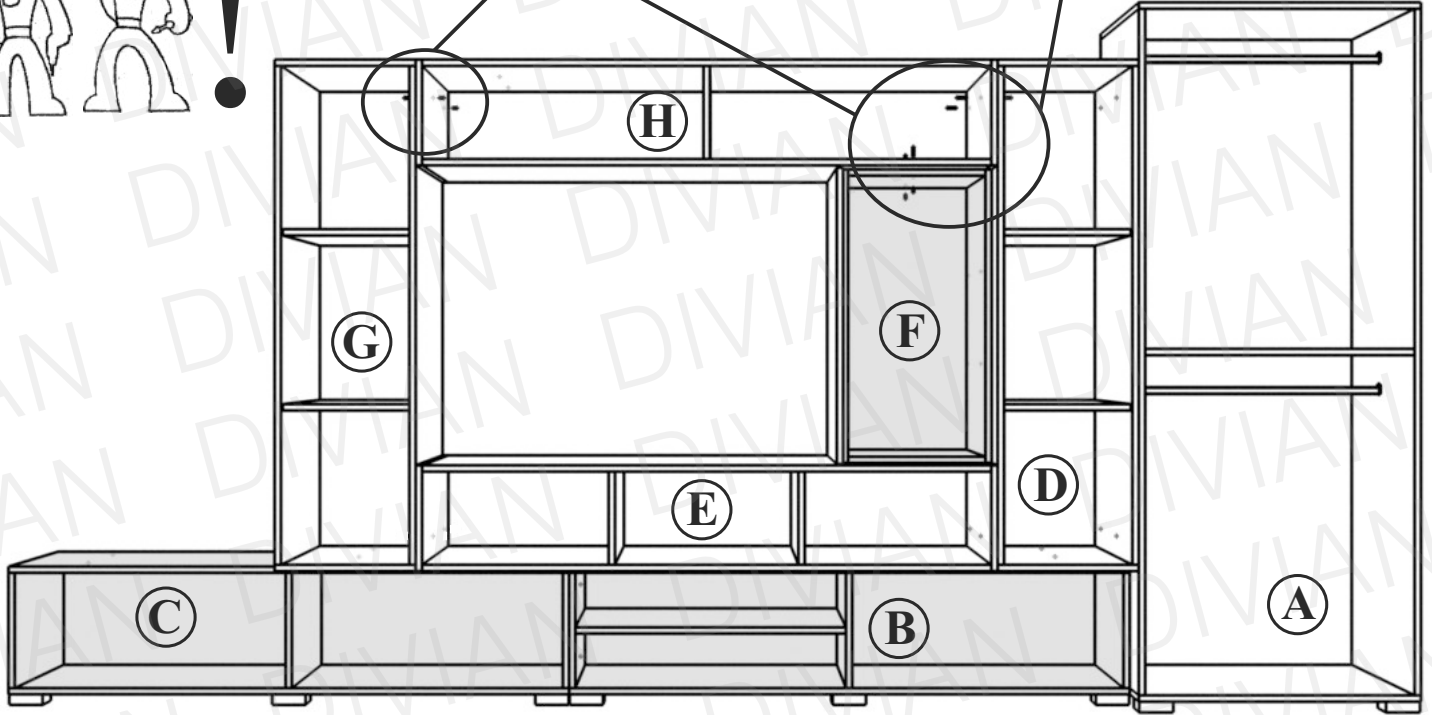
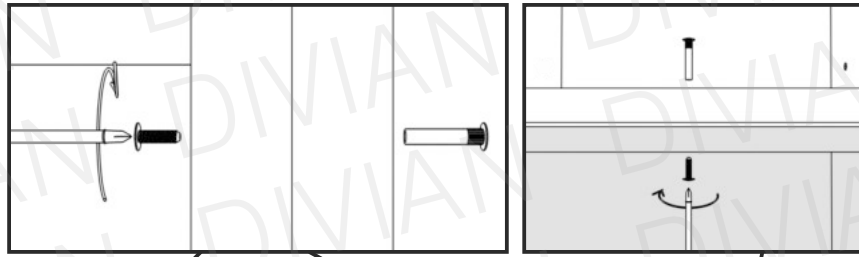
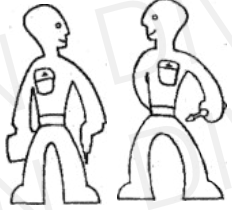

6



i

I

Fogó jobb oldalt
Hátfalak síkban legyenek.

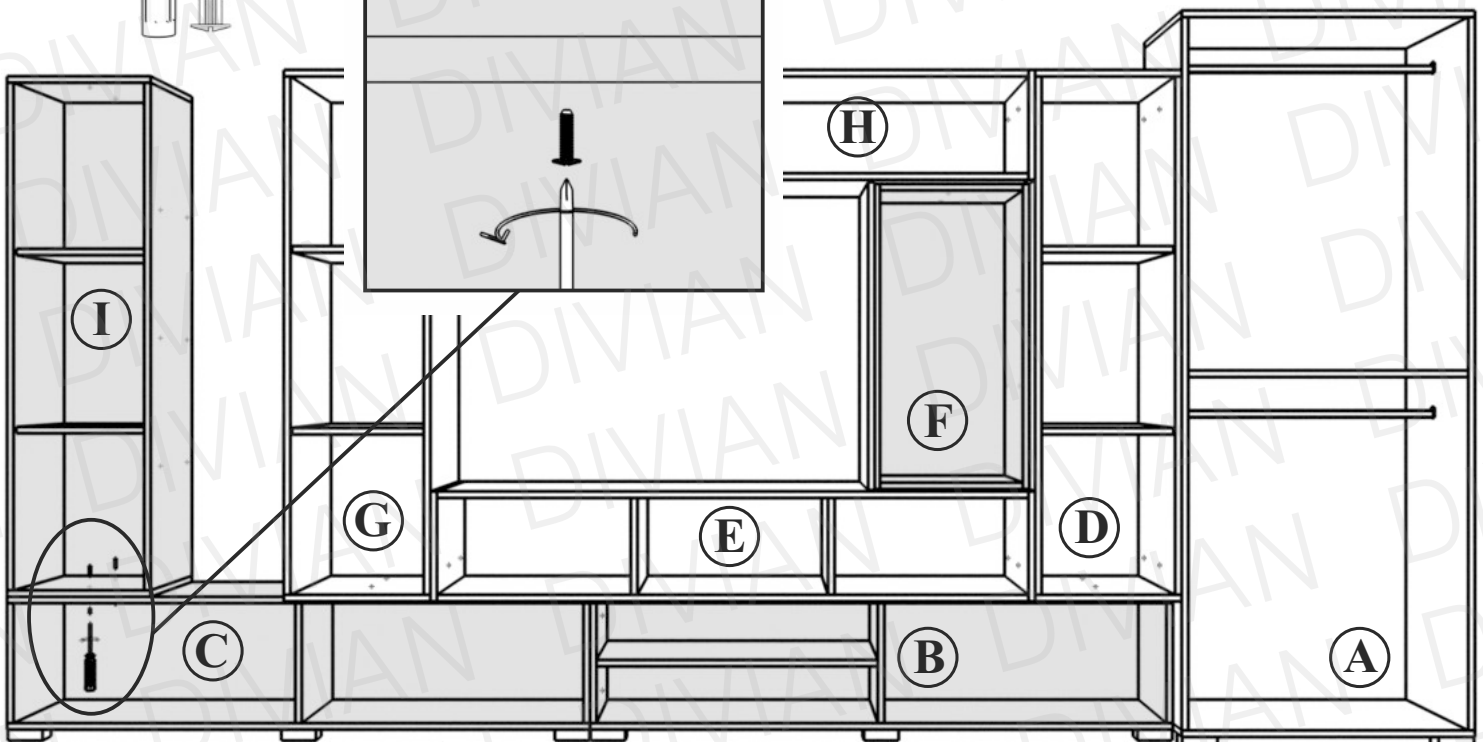

7

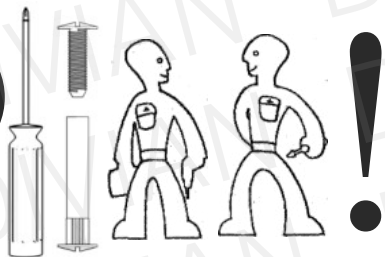

i **J** Fogó alul. Hátfalak síkban legyenek.

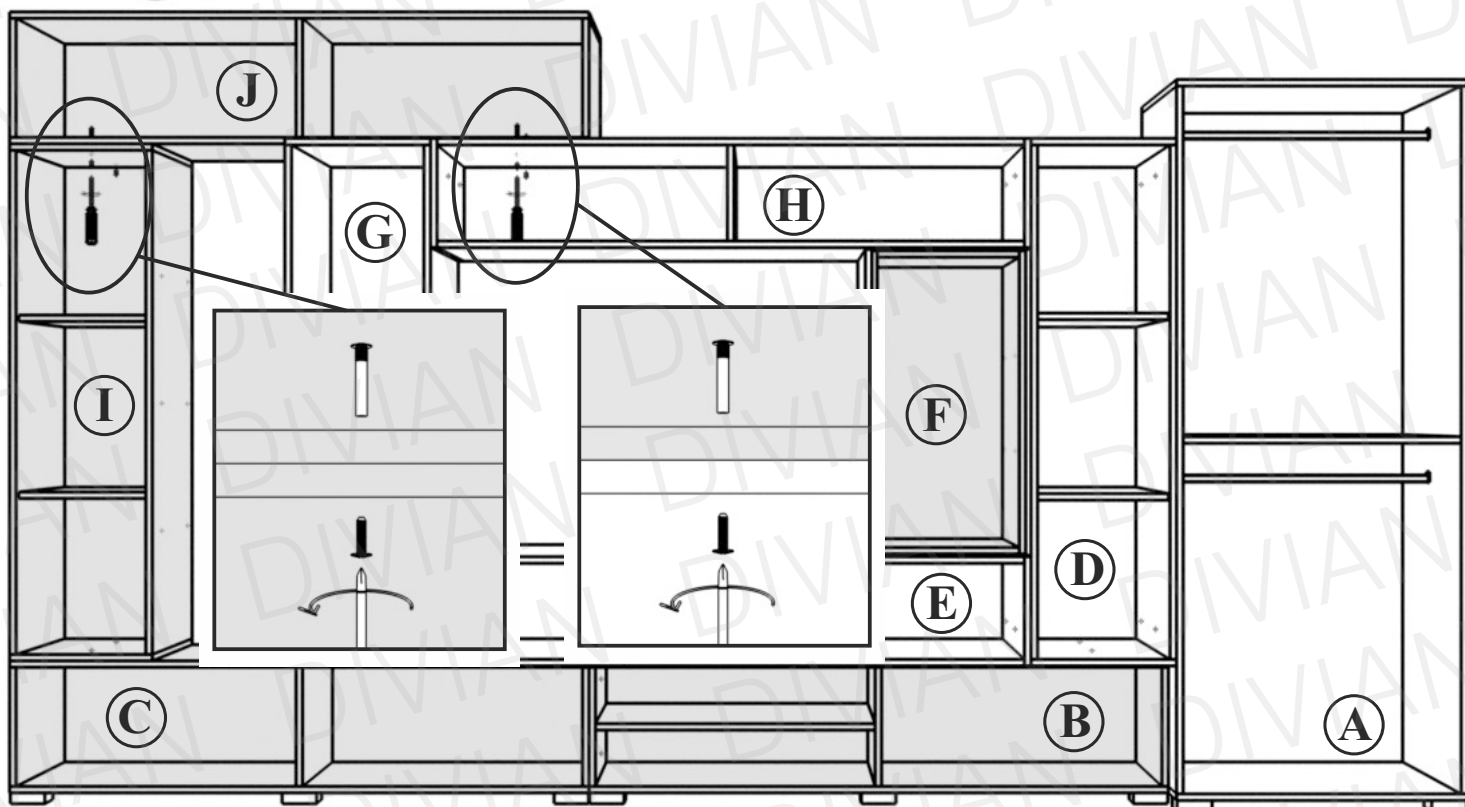

8

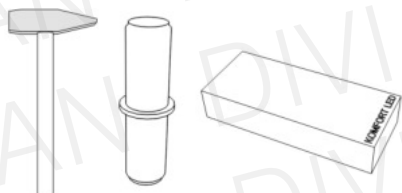

i A **LED világítás** szerelési útmutatóját megtalálja a LED szett dobozában!

