

CANADA

**szekrény sor
és gardrób**



SZERELÉSI ÚTMUTATÓ

Szekrény csomag tartalma:



bútorösszehúzó M6x30 16db

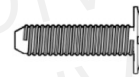

bútorösszehúzó M4x12 16db

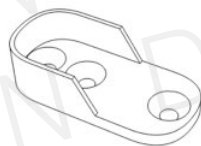

rúdtárcsa 2db



3,5x16 csavar 4db



Konfirmátor csavar 4db



polctartó 20db

Gardrób csomag tartalma:

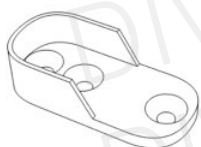

rúdtárcsa 2db



3,5x16 csavar 4db



polctartó 4db

Szükséges szerszámok:

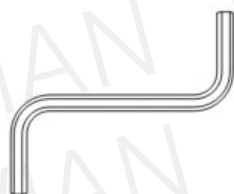
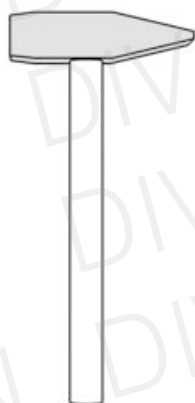

Ne egyedül végezze az összeállítást!

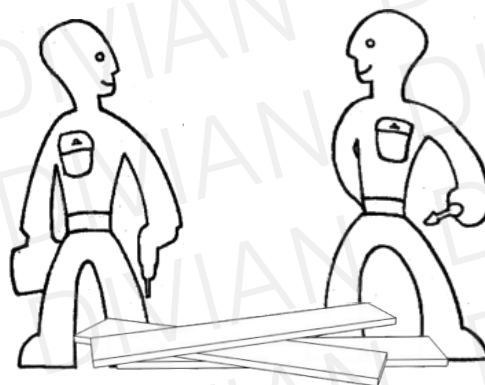

Óvja az elemeket a sérülésektől!

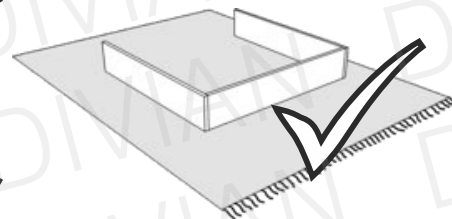
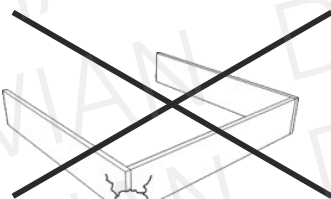

A csomagok több alkatrészt tartalmazhatnak, mint amennyire szüksége van!

ELEMEK

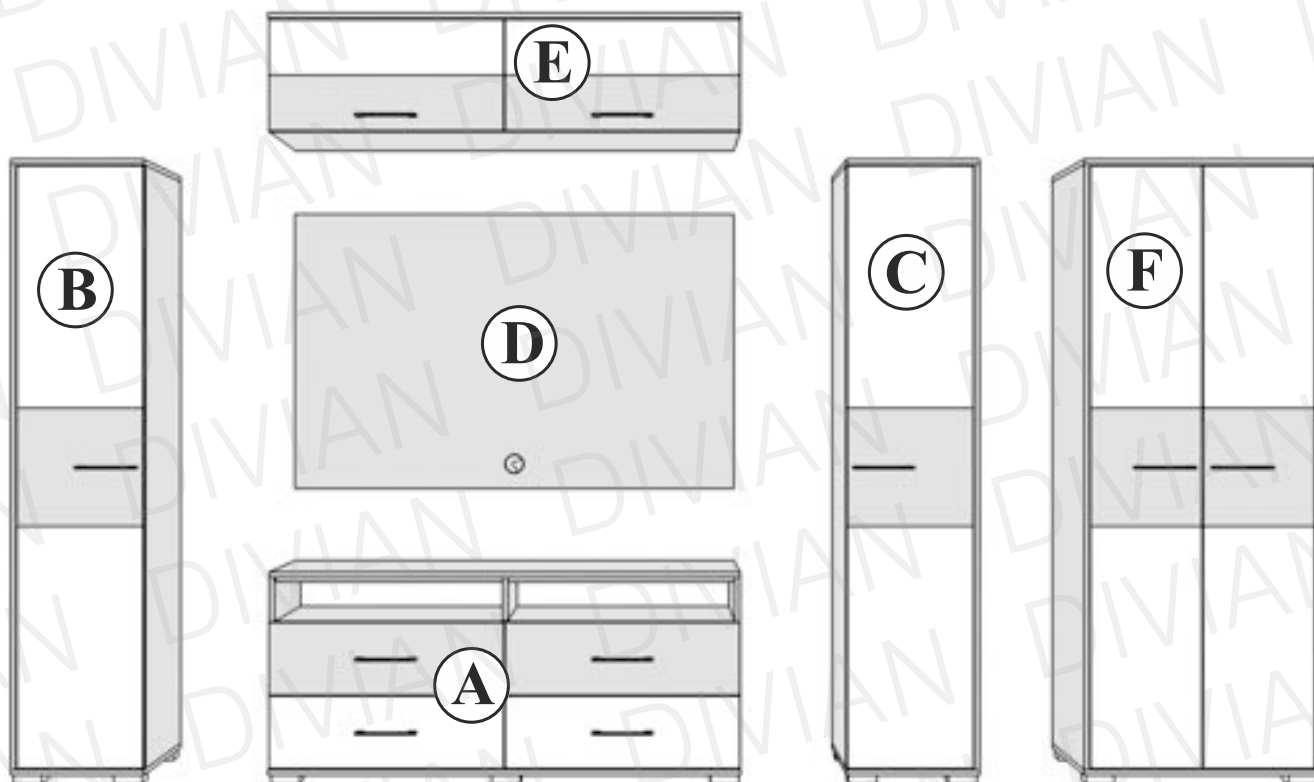

A könnyebb áttekinthetőség érdekében a szerelési útmutatóban az adott elemeket ajtók és fiókok nélkül ábrázoljuk. Az összeszereléshez Önnek természetesen nem szükséges levennie az ajtókat!

1



Távolítsa el az alsó 2 fiókot!
Könnyebb szerelés érdekében,
mind a 4 fiók eltávolítható.

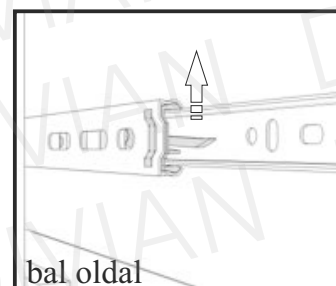
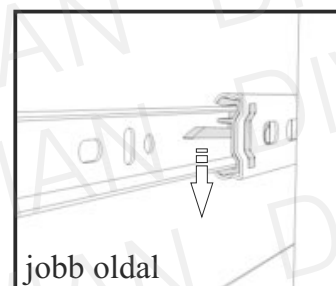
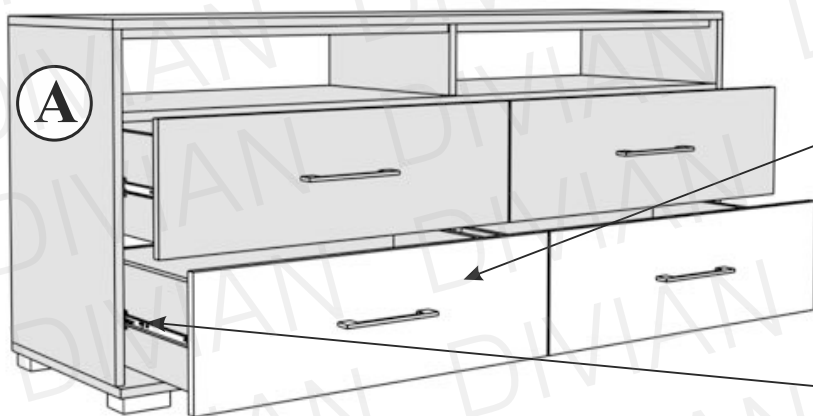

Fiók eltávolításához, húzza ki teljesen a fiókot, és bal oldalt nyomja felfele, jobb oldalt nyomja lefele a műanyag kis kart, és húzza tovább a fiókot.

2

4x M6x30 4x M4x12

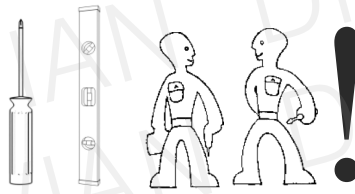

i Hátfalak síkban legyenek.

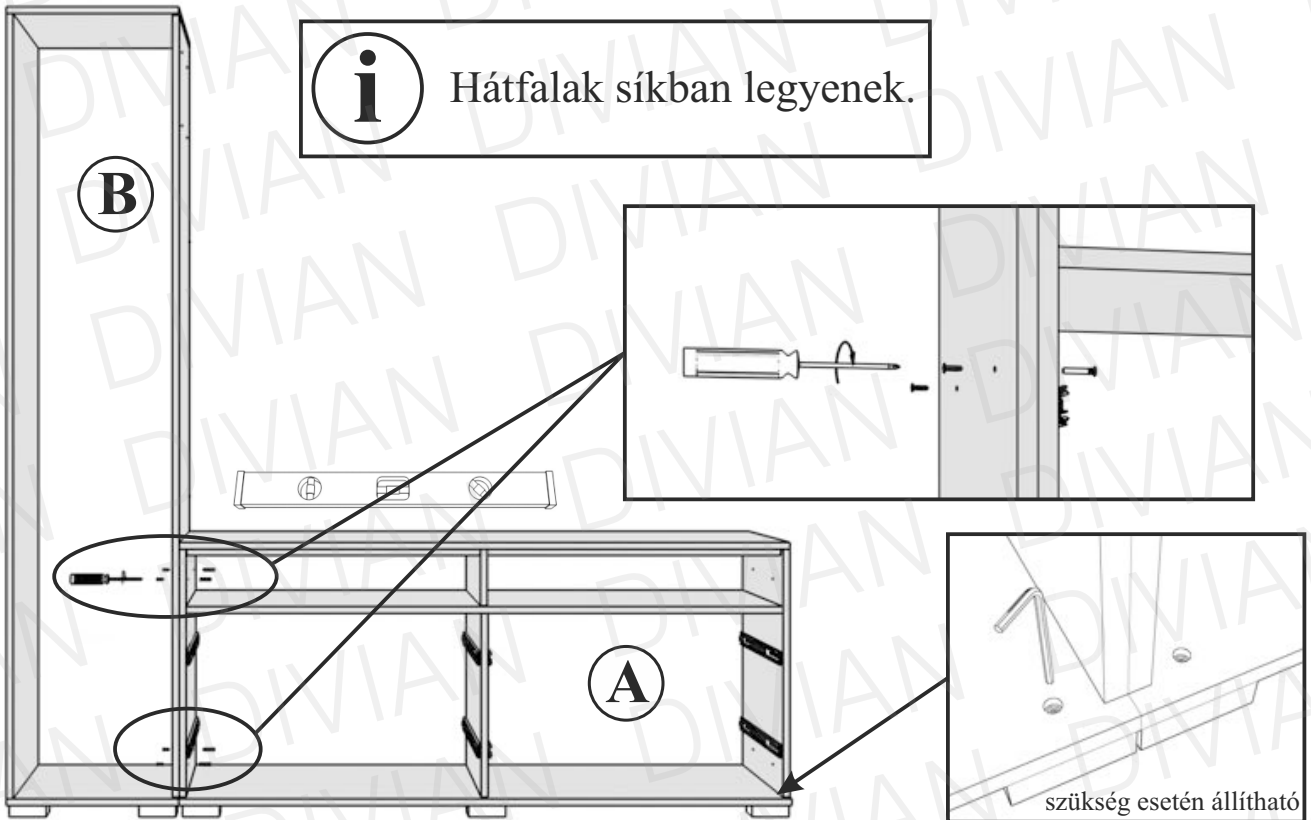

3

4x M6x30 4x M4x12

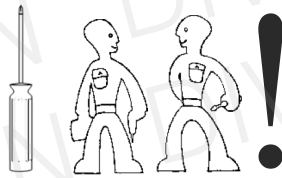

i Hátfalak síkban legyenek.

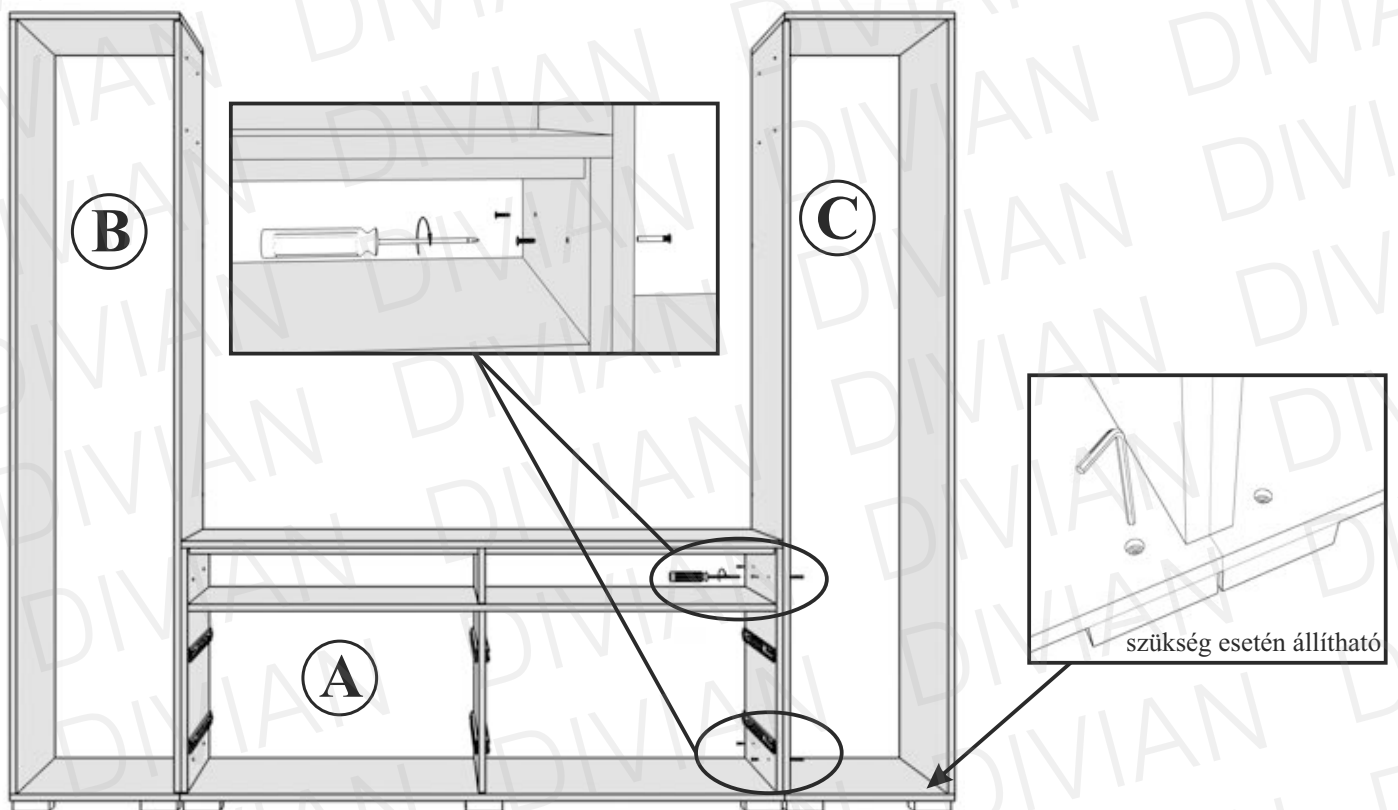

4

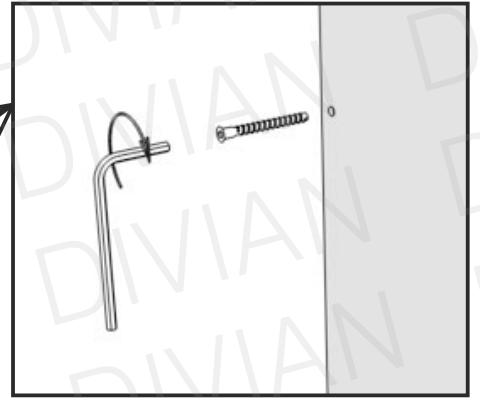
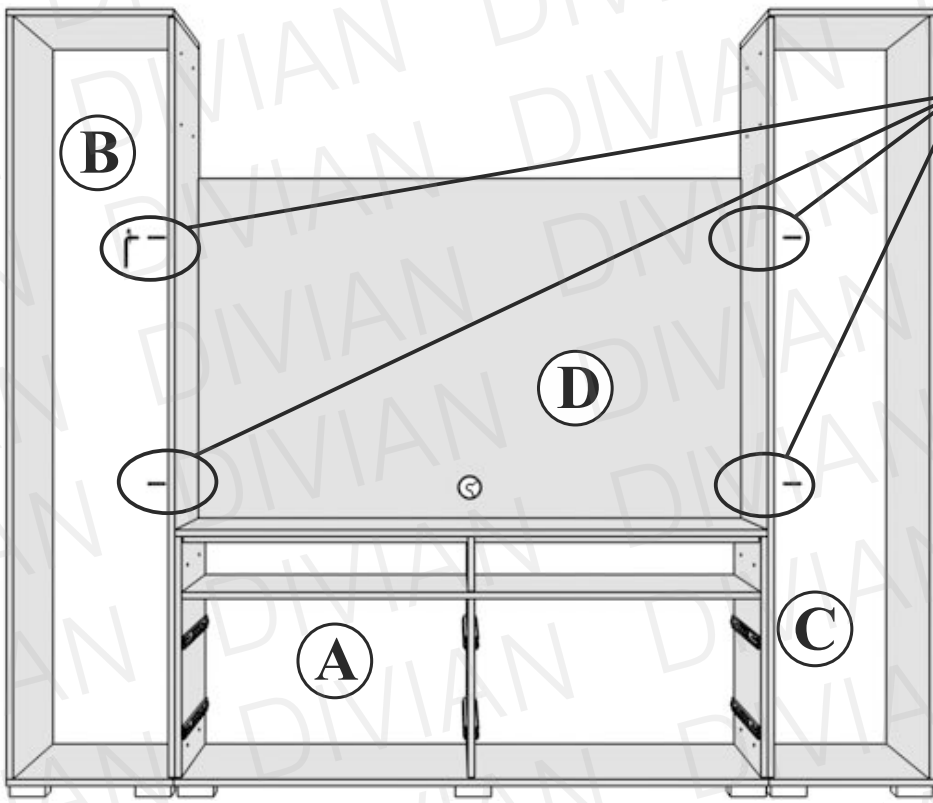
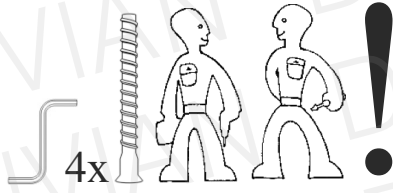

5

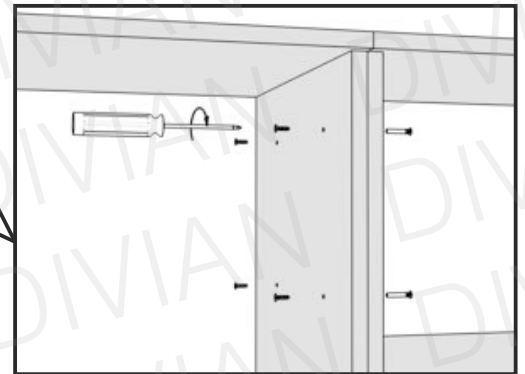
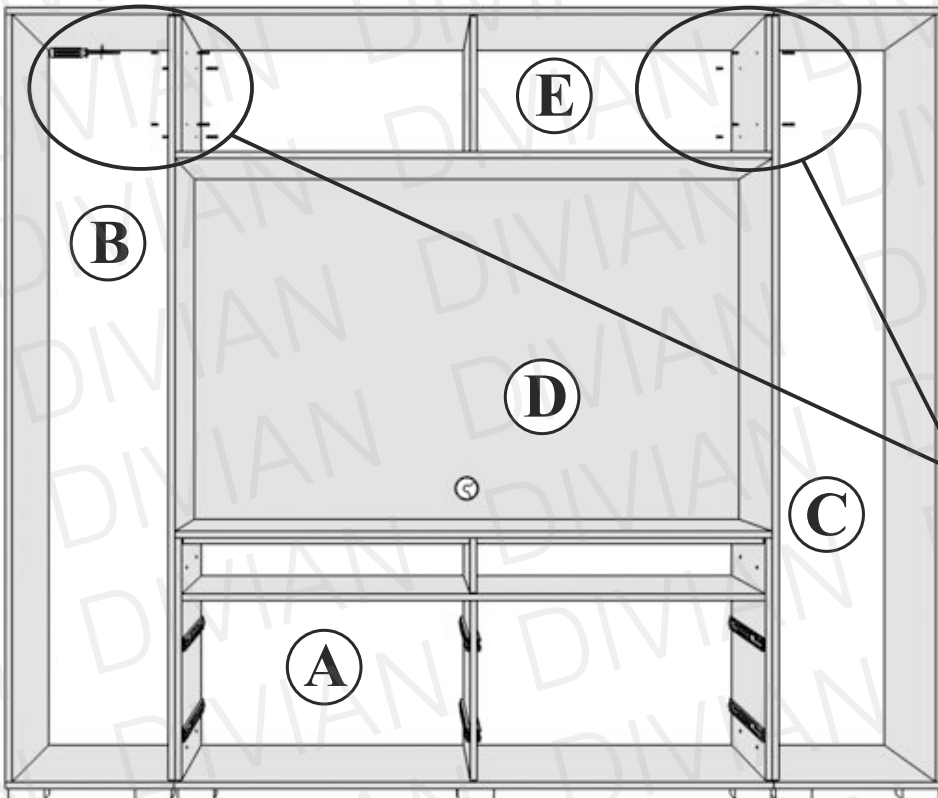

6

20x

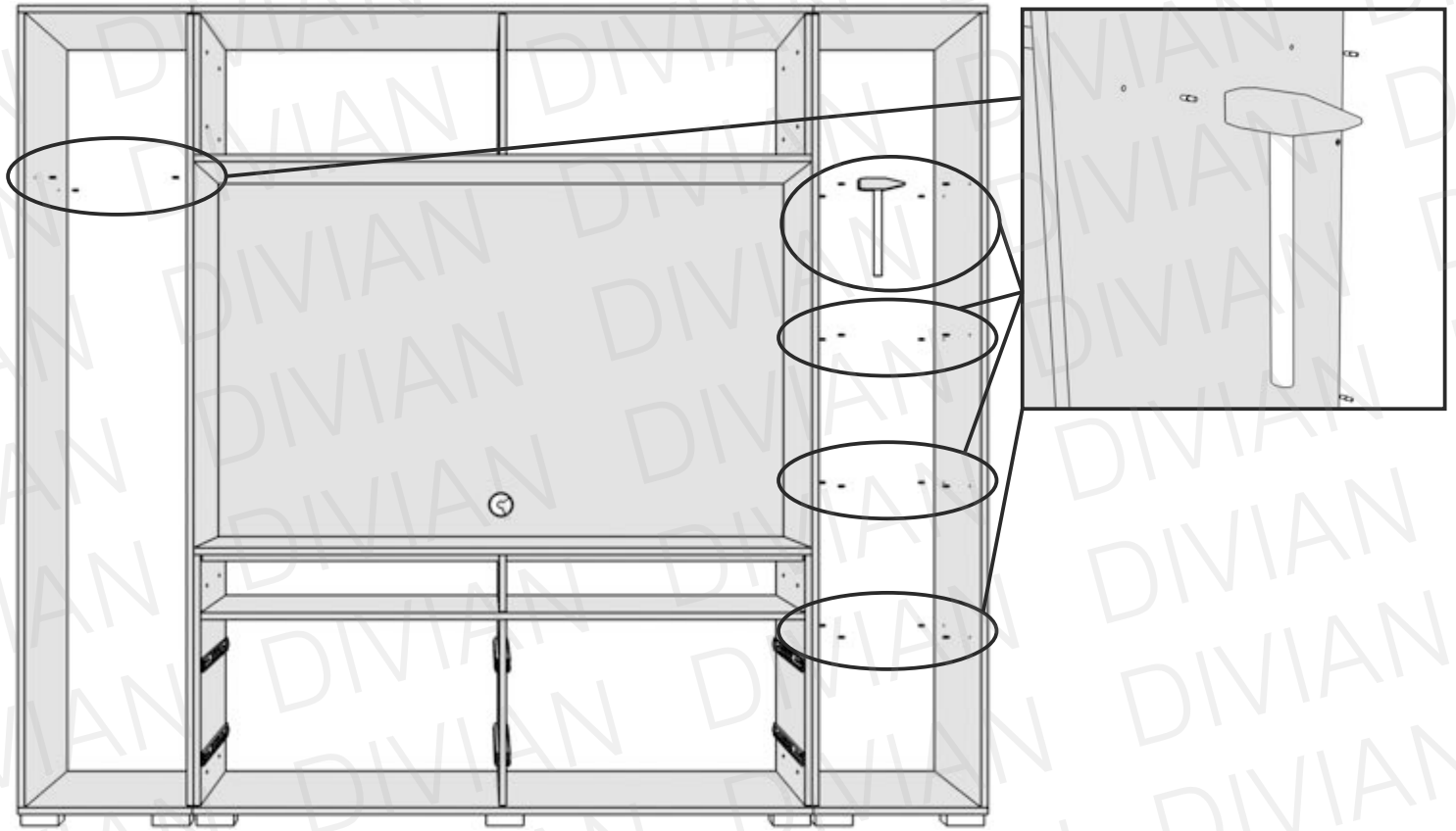
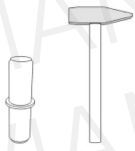

7

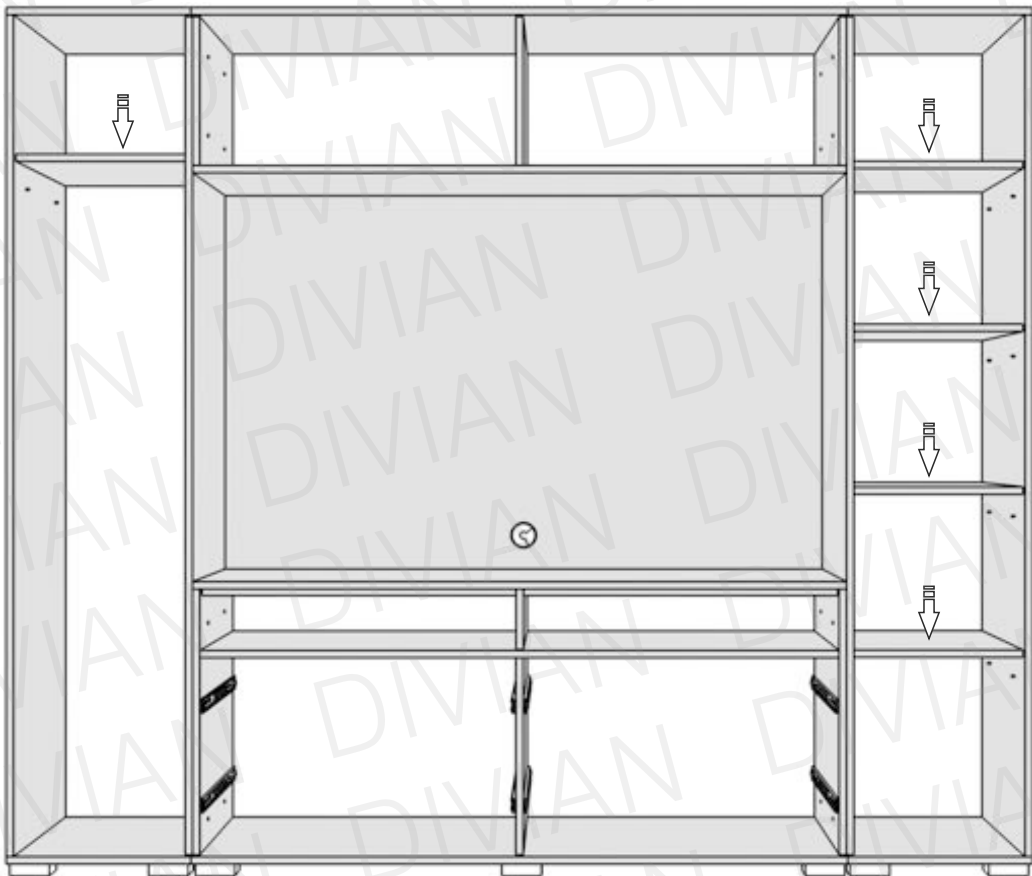

8

2x



4x

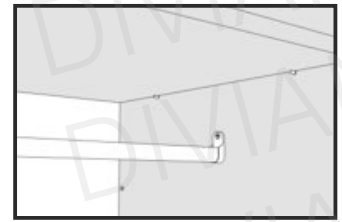
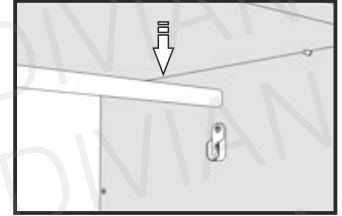
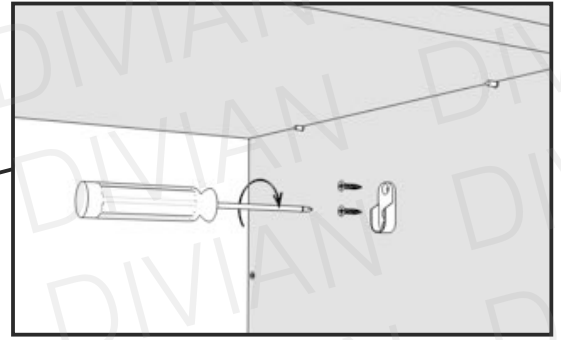
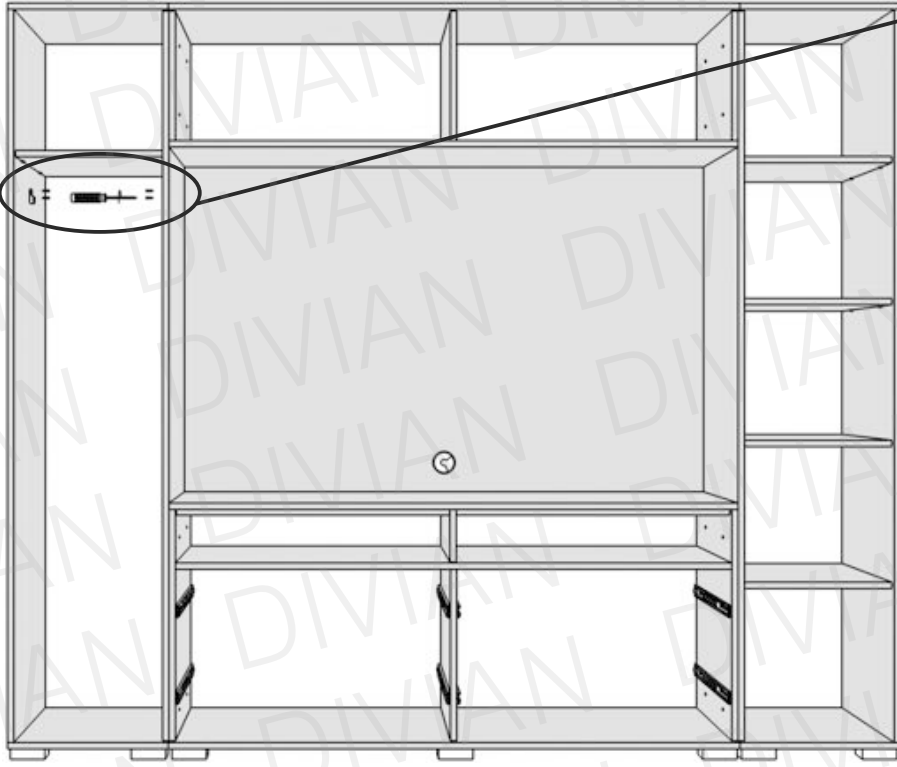

9

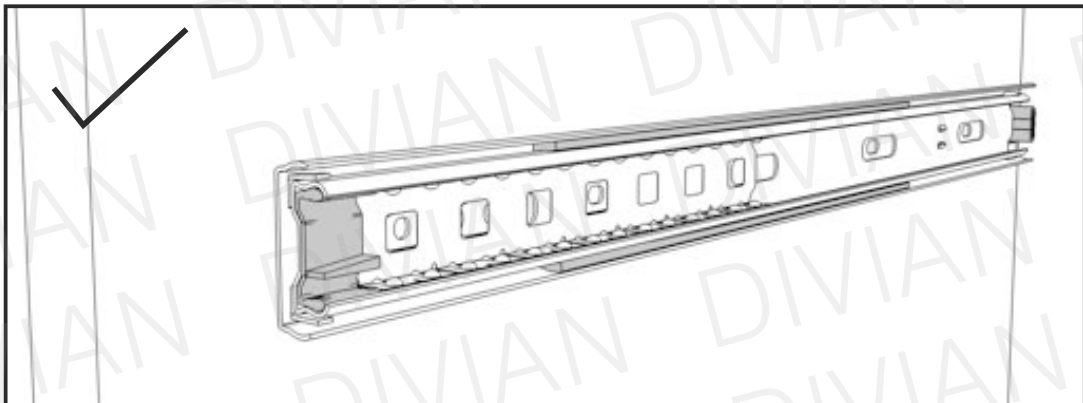
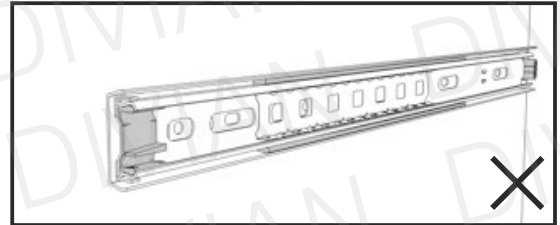
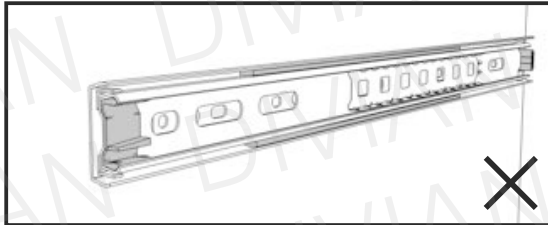

i

A fiók behelyezése előtt, állítsa a megfelelő helyzetbe a síneket! A sínt állítsa zárt állapotba, a görgős elemrészt feltétlenül húzza egészen előre!

10

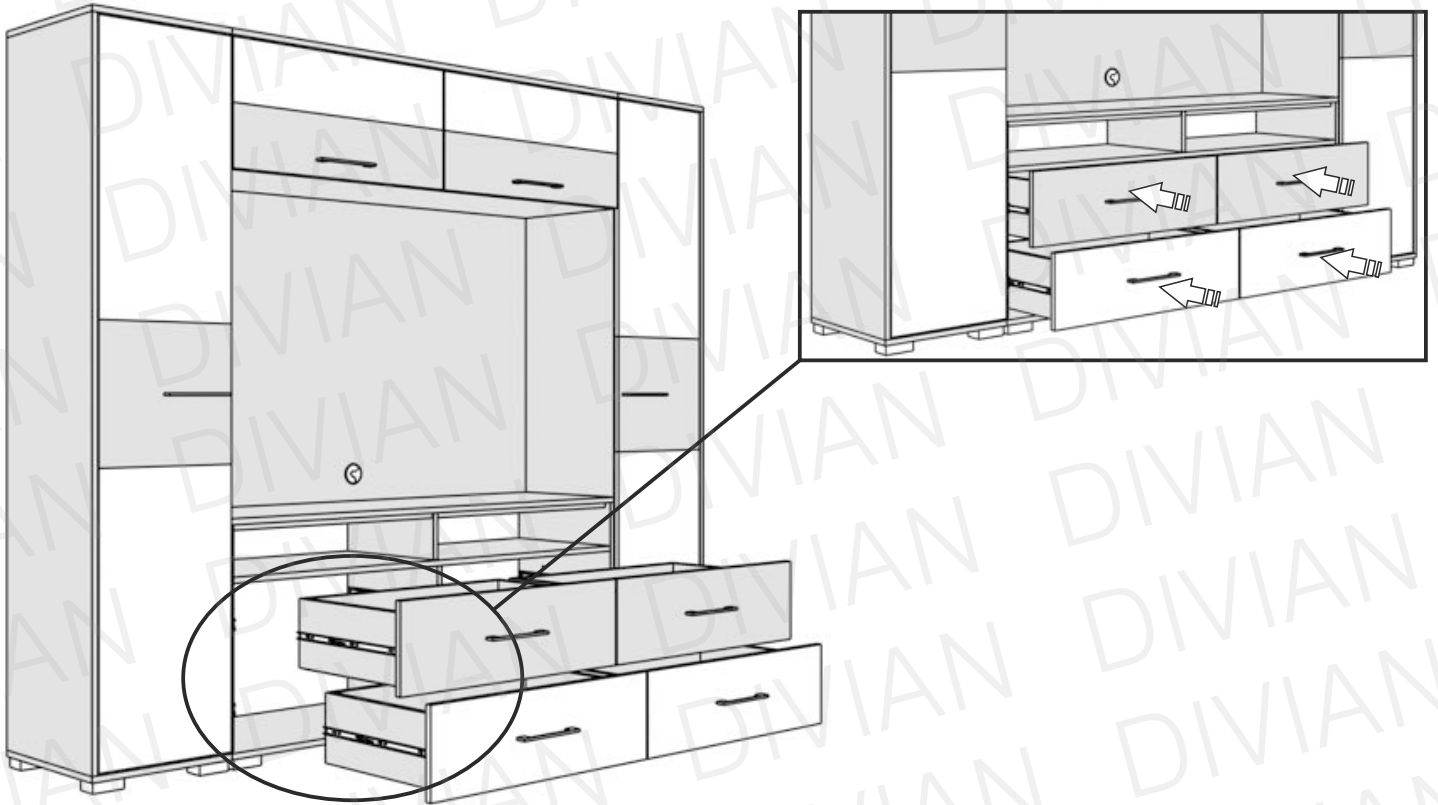

Pontos illesztés

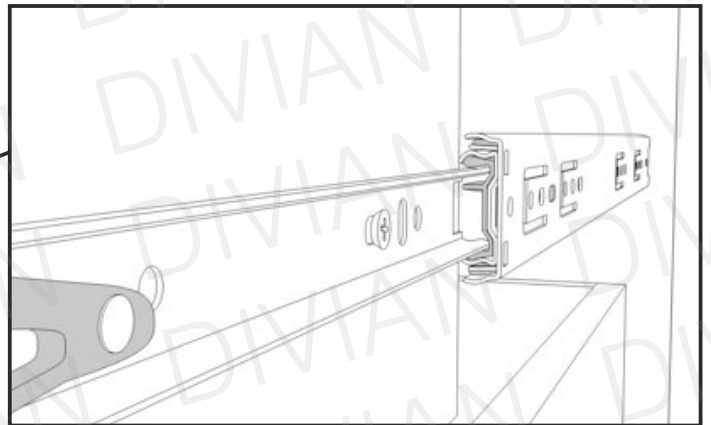
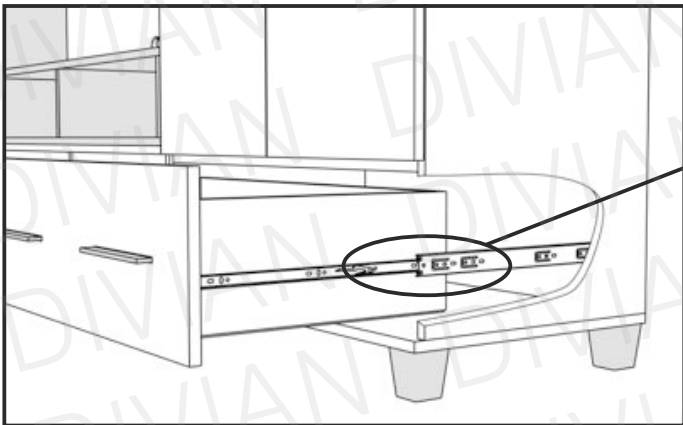

Illesszék a fióktestre szerelt sín párt a korpuszon található sínhez, mindkét oldalt ellenőrizték, hogy sikerült-e pontosan beilleszteni. Ezután tolják be a fiókot.

Ha nem sikerült elsőre, semmiképpen se rángassák a fiókot, húzzák vissza ki, és a 9. lépés szerint állítsák be a korpuszon található sín, majd ismételjék meg a 10. pontot.

11

4x

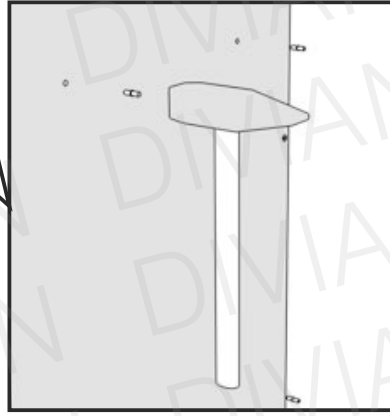
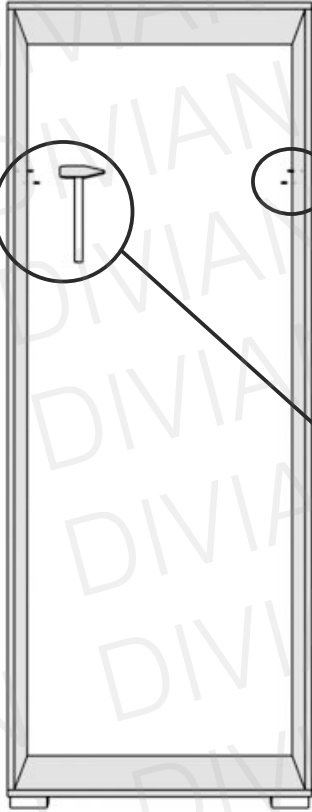

12

2x



4x

